



# MTA, CST-100 II, SL-156 and AMP Economy Power (EP) Connectors

## Table of Contents

### Introduction

This catalog has been designed to assist you, our customer, identify products to satisfy your connector needs for printed circuit board headers, mass termination connectors preloaded with contacts, crimp-snap contacts and housings, and card edge connectors with preloaded contacts.

The list at right identifies by centerline the types of product available and is meant to be of assistance to you in the product selection process.



**IDC**  
**MTA-50**



**IDC**  
**MTA-100**



**Crimp**  
**CST-100 II**



**IDC**  
**MTA-156**

© 1977, 1978, 1979, 1980, 1983, 1986, 1988, 1992, 1993, 1994, 1995, 1999, 2000, 2001, 2002, 2003 and 2005 by Tyco Electronics Corporation.

All International Rights Reserved.  
AMP, AMP-O-LECTRIC, AMP-O-MATIC, AMPOMATOR, CERTI-CRIMP, PRO-CRIMPER, MADISON CABLE and TYCO are trademarks.

TEFLON is a trademark of E.I. DuPont De Nemours and Company.

Other products, logos, and company names mentioned herein may be trademarks of their respective owners.

|   |        |
|---|--------|
| <b>Introduction and Table of Contents</b> .....                         | 2, 3   |
| <b>Connector Selection Guide</b> .....                                  | 3      |
| <b>.050 [1.27] Centerline Connectors</b>                                |        |
| <b>MTA-50 IDC Connectors and Headers</b> .....                          | 4-10   |
| Introduction and Wire-to-Board Mateability Guide .....                  | 4      |
| IDC Connector Kits (Feed-Thru and Closed End)                           |        |
| Ribbon Cable .....  | 5, 6   |
| Discrete Wire .....   | 7, 8   |
| Through-Hole Header Assemblies  |        |
| Vertical and Right-Angle .....  | 9      |
| Surface Mount Header Assemblies   |        |
| Vertical and Right-Angle .....  | 10     |
| <b>.100 [2.54] Centerline Connectors</b>                                |        |
| <b>MTA-100 IDC Connectors and Headers</b> .....                         | 11-31  |
| Introduction .....  | 11     |
| Wire-to-Board Mateability Guide .....                                   | 12, 13 |
| Connectors—UL94V-2 and UL94V-0  |        |
| Closed End with and without Polarizing Tab .....                        | 14, 15 |
| Feed-Thru with and without Polarizing Tab .....                         | 14, 15 |
| LED Closed End and Feed-Thru—UL94V-2 .....                              | 14, 15 |
| Accessories .....   | 16, 17 |
| Posted Connectors Mateability Guide .....                               | 18, 19 |
| MTA-100 Posted Connectors (Wire-to-Wire) UL94V-2                        |        |
| Closed End .....  | 20     |
| Feed-Thru .....   | 20     |
| Headers—UL94V-0   |        |
| Flat—Straight and Right-Angle Posts .....                               | 21     |
| Narrow Flat—Straight and Right-Angle Posts .....                        | 22     |
| Polarized—Straight and Right-Angle Posts .....                          | 23     |
| Friction Lock—Straight and Right-Angle Posts .....                      | 24     |
| Headers with Retention Peg—Straight Posts .....                         | 25     |
| High Profile Headers—Right-Angle Posts .....                            | 26     |
| Polarized—High Temperature, Straight and Right-Angle Posts .....        | 27     |
| Friction Lock—High Temperature, Straight and Right-Angle Posts .....    | 28     |
| Polarized—Surface Mount, Straight .....                                 | 29     |
| Friction Lock—Surface Mount, Straight .....                             | 29     |
| Shrouded—Straight and Right-Angle Posts .....                           | 30     |
| <b>CST-100 II Crimp Contacts, Housings and Shrouded Headers</b> .....   | 31, 32 |
| <b>.156 [3.96] Centerline Connectors</b>                                |        |
| <b>MTA-156 IDC Connectors and Headers</b> .....                         | 33-57  |
| Introduction .....  | 33     |
| Wire-to-Board Mateability Guide .....                                   | 34, 35 |
| Connectors—UL94V-2 and UL94V-0  |        |
| Closed End with Locking Ramp, with and without Polarizing Tabs .....    | 36, 37 |
| Closed End without Locking Ramp, with and without Polarizing Tabs ..... | 36, 37 |
| Feed-Thru with Locking Ramp, with and without Polarizing Tabs .....     | 38, 39 |
| Feed-Thru without Locking Ramp, with and without Polarizing Tabs .....  | 38, 39 |
| Accessories .....   | 40-42  |
| Posted Connectors Mateability Guide .....                               | 43, 44 |
| MTA-156 Posted Connectors (Wire-to-Wire)—UL94V-2                        |        |
| Closed End .....  | 45     |
| Feed-Thru .....   | 45     |
| MTA-156 Headers—UL94V-0   |        |
| Flat—Straight Posts .....   | 46     |
| Flat—Right-Angle Posts .....  | 47     |
| Friction Lock—Straight Posts .....                                      | 48     |
| Friction Lock—Right-Angle Posts .....                                   | 49     |
| Polarized Lock—Straight Posts .....                                     | 50     |
| Polarized Lock—Right-Angle Posts .....                                  | 51     |
| Friction Lock—High Temperature, Straight Posts .....                    | 52     |
| Shrouded—Straight and Right-Angle Posts .....                           | 53     |
| <b>MTA-156 Quad Connectors—UL94V-0</b> .....                            | 54, 55 |
| Closed End with Locking Ramp .....                                      | 55     |
| Feed-Thru with Locking Ramp .....                                       | 55     |

**Table of Contents** (Continued)



**Crimp  
SL-156**



**Crimp  
AMP EP Connectors**

**Need more information?**

Call Technical Support at the numbers listed below.

Technical Support is staffed with specialists well versed in Tyco Electronics products. They can provide you with:

- Technical support
- Catalogs
- Technical Documents
- Product Samples
- Authorized Distributor Locations

**MTA-156 Card Edge** ..... 56, 57  
 Connectors — UL94V-0  
     Closed End with and without Mounting Ears ..... 56  
     Feed-Thru with and without Mounting Ears ..... 56  
 Accessories ..... 57  
**SL-156 Crimp Connectors and Headers** ..... 58-62  
 Wire-to-Board Mateability Guide ..... 58  
 Wire-to-Board Crimp Contacts and Keying Plugs ..... 59  
 Wire-to-Board Housings — UL94V-0 ..... 60  
 Housings with Through Board Latch — UL94V-2 ..... 61  
 Housings and Contacts for Large Insulation Diameter (LID) Wire ..... 62  
**AMP Economy Power (EP) Connector System** ..... 63-69  
   **.156 [3.96] Centerline Connectors**  
     Introduction ..... 63  
     Crimp Contacts ..... 64  
     Plug Housings, Low-Profile ..... 64  
     Low-Profile Headers — Straight and Right-Angle Posts ..... 65  
     Low-Profile Headers, High Temp. — Straight and Right-Angle Posts ..... 66  
   **.200 [5.08] Centerline Connectors**  
     Plug Housings and Straight and Right-Angle Post Headers ..... 67  
   **.312 [7.92] Centerline Connectors**  
     Low-Profile Headers — Straight Posts ..... 68  
**Single Connectors**  
   1-Position Plug Housing and High-Profile Header — Straight Post ..... 69  
**MTA Wire Selection and Ribbon Cable Preparation** ..... 70  
**IDC Ribbon Cable** ..... 71-74  
**MTA Wire Termination Flowchart** ..... 75  
**MTA Application Tooling** ..... 76-79  
**Part Number Index** ..... 80-82  
**Global Contacts** ..... 83

**Connector Selection Guide**

| Product Name                                       | Centerline   | Contact Termination | Wire-to-Wire Option | No. of Positions                  | Wire Size (AWG) | Wire Insulation Dia. Max. | Current Rating (A)**          | Voltage Rating Max. (VAC) | Operating Temp. Range (°C) | UL Flammability | Replacement Contacts | Approvals   |
|--|--------------|---------------------|---------------------|-----------------------------------|-----------------|---------------------------|-------------------------------|---------------------------|----------------------------|-----------------|----------------------|---|
| <b>.050" Centerline</b>                            |              |                     |                     |                                   |                 |                           |                               |                           |                            |                 |                      |   |
| MTA-50 IDC Connector Kits and Headers              | .050<br>1.27 | IDC                 | Planned             | 2–28                              | 30–26           | .039*<br>0.99             | 1                             | 30                        | –55 to +105                | V-0 & V-2       | No                   |  |
| <b>.100" Centerline</b>                            |              |                     |                     |                                   |                 |                           |                               |                           |                            |                 |                      |   |
| MTA-100 Connectors and Headers                     | .100<br>2.54 | IDC                 | Yes                 | 2–28                              | 28–22           | .060*<br>1.52             | 5                             | 250                       | –55 to +105                | V-0 & V-2       | Yes                  |  |
| CST-100 II Contacts and Housings                   | .100<br>2.54 | Crimp               | Planned             | 2–28                              | 26–22           | .065<br>1.65              | 4                             | 250                       | –55 to +105                | V-0             | Yes                  |  |
| <b>.156" Centerline</b>                            |              |                     |                     |                                   |                 |                           |                               |                           |                            |                 |                      |   |
| MTA-156 Connectors and Headers                     | .156<br>3.96 | IDC                 | Yes                 | 2–24                              | 26–18           | .095*<br>2.41             | 7                             | 600                       | –55 to +105                | V-0 & V-2       | Yes                  |  |
| Quad Connectors                                    | .156<br>3.96 | IDC                 | No                  | 2–12                              | 22–18           | .095*<br>2.41             | 12.5                          | 600                       | –55 to +105                | V-0             | Yes                  |  |
| SL-156 Contacts and Housings                       | .156<br>3.96 | Crimp               | No                  | 1–24; 2–10 w/ through board latch | 24–18           | .105<br>2.67              | 10                            | 250                       | –25 to +105                | V-0             | Yes                  |  |
| SL-156 Large Ins. Dia. (LID) Contacts and Housings | .156<br>3.96 | Crimp               | No                  | 2–24                              | 24–16           | .112<br>2.84              | 10                            | 250                       | –25 to +105                | V-0             | Yes                  |  |
| <b>.156", .200" and .312" Centerlines</b>          |              |                     |                     |                                   |                 |                           |                               |                           |                            |                 |                      |   |
| AMP Economy Power (EP) Connector System            | .156<br>3.96 | Crimp               | No                  | 1–12                              | 22–18           | .118<br>3.00              | 8 (1 pos.)<br>7.5 (2–12 Pos.) | 250                       | –25 to +105                | V-0             | Yes                  |  |
|  | .200<br>5.08 | Crimp               | No                  | 2–12                              | 22–18           | .118<br>3.00              | 7.5 (2–12 Pos.)               | 250                       | –25 to +105                | V-0             | Yes                  |  |
|  | .312<br>7.92 | Crimp               | No                  | 2–5                               | 22–18           | .118<br>3.00              | 7.5 (2–5 Pos.)                | 250                       | –25 to +105                | V-0             | Yes                  |  |

\* When terminated one position at a time.  
 \*\* Current Rating is application dependent.



**MTA-50 IDC Connectors and Headers**

**Product Facts**

- 2-28 contact positions
- Connectors terminate 26, 28 and 30 AWG discrete wire or .050 [1.27] centerline ribbon cable
- Color-coded housings
- Maximum cable insulation diameter of .039 [0.99] with PVC insulation only
- IDC contacts pre-loaded in receptacle housing
- 30 V, 1 A contact rating
- Contact design allows for gold-to-gold or tin-to-tin interface
- Contacts are lubricated to prevent fretting corrosion
- Wire feed-thru capability for daisy-chain wiring or closed end for point-to-point wiring
- Connectors are polarized for proper mating
- Manual and semiautomatic application tooling
- Mating heights shown below:



- Component Recognized by Underwriters Laboratories Inc. to US and Canadian Standards, File No. E28476 C **UL** US (Connectors and Headers) File No. E53793 (Ribbon Cable)

These matrices have been prepared to assist you in defining the correct mating halves for the MTA-50 header and connector kit combination. Where a "Y" is indicated the combination is a valid mating pair.

**Note:** Tyco Electronics does NOT recommend intermating connectors and headers with different contact platings.



The MTA-50 IDC Connector System is a wire-to-printed circuit board system with contacts in a staggered, single row on .050 [1.27] centerline. The design features wire feed-through capability for daisy-chain applications. Insulation displacement contacts are used to terminate a wide range of conductor sizes. Ribbon cable can also be terminated when the appropriate receptacle assembly and strain relief cover are used.

Header assemblies for board mount applications include right-angle (horizontal) and vertical mount products. These are available in

through-hole and surface mount configurations.

Typical uses of the MTA-50 IDC connectors would be in the Appliance, Commercial and Home Equipment and Security products industries.

See the following pages for related products:

- Ribbon Cable (reels), .050 [1.27] centerline (p. 71)
- Application Tooling (p. 76)
- Cable Assemblies (p. 74)

**Performance Data**

- Voltage Rating** — 30 VAC
- Current Rating** — 1 amp max.
- Low-Level Resistance** — 30 milliohms

**Dielectric Withstanding Voltage** — 500 VAC

**Insulation Resistance** — 1,000 megohms

**Operating Temperature** — -55°C to +105°C for connector only; cable rating may be lower

**Technical Documents**

**Application Specification** — 114-13072 MTA-50 Connectors

**Product Specifications** — 108-2113 MTA-50 Connectors

100-4703 MADISON CABLE Cable Specification (28 AWG, 7/36 Tinned copper, PVC insulation)

100-6257 MADISON CABLE Cable Specification (28 AWG, 7/36 Tinned copper, TPO insulation)

**MTA-50 IDC Connector Kit / Header Mateability Guide**

| Connector Kits | Headers |         |         |         |
|----------------|---------|---------|---------|---------|
|                | 1445120 | 1445121 | 1445169 | 1445172 |
| 1445341        | Y       | Y       | Y       | Y       |
| 1445344        | Y       | Y       | Y       | Y       |
| 1445347        | Y       | Y       | Y       | Y       |
| 1445350        | Y       | Y       | Y       | Y       |
| 1445353        | Y       | Y       | Y       | Y       |
| 1445356        | Y       | Y       | Y       | Y       |
| 1445359        | Y       | Y       | Y       | Y       |
| 1445362        | Y       | Y       | Y       | Y       |
| 1445365        | Y       | Y       | Y       | Y       |
| 1445368        | Y       | Y       | Y       | Y       |
| 1445371        | Y       | Y       | Y       | Y       |
| 1445374        | Y       | Y       | Y       | Y       |

**Matrix for Tin Plated Part Numbers**

| Connector Kits | Headers |         |         |         |
|----------------|---------|---------|---------|---------|
|                | 1445125 | 1445126 | 1445171 | 1445174 |
| 1445343        | Y       | Y       | Y       | Y       |
| 1445346        | Y       | Y       | Y       | Y       |
| 1445349        | Y       | Y       | Y       | Y       |
| 1445352        | Y       | Y       | Y       | Y       |
| 1445355        | Y       | Y       | Y       | Y       |
| 1445358        | Y       | Y       | Y       | Y       |
| 1445361        | Y       | Y       | Y       | Y       |
| 1445364        | Y       | Y       | Y       | Y       |
| 1445367        | Y       | Y       | Y       | Y       |
| 1445370        | Y       | Y       | Y       | Y       |
| 1445373        | Y       | Y       | Y       | Y       |
| 1445376        | Y       | Y       | Y       | Y       |

**Matrix for .00030 [0.00076] Gold Plated Part Numbers**

| Connector Kits | Headers |         |         |         |
|----------------|---------|---------|---------|---------|
|                | 1445123 | 1445124 | 1445170 | 1445173 |
| 1445342        | Y       | Y       | Y       | Y       |
| 1445345        | Y       | Y       | Y       | Y       |
| 1445348        | Y       | Y       | Y       | Y       |
| 1445351        | Y       | Y       | Y       | Y       |
| 1445354        | Y       | Y       | Y       | Y       |
| 1445357        | Y       | Y       | Y       | Y       |
| 1445360        | Y       | Y       | Y       | Y       |
| 1445363        | Y       | Y       | Y       | Y       |
| 1445366        | Y       | Y       | Y       | Y       |
| 1445369        | Y       | Y       | Y       | Y       |
| 1445372        | Y       | Y       | Y       | Y       |
| 1445375        | Y       | Y       | Y       | Y       |

**Matrix for .00015 [0.00038] Gold Plated Part Numbers**

**MTA-50 IDC Connectors and Headers (Continued)**

**Feed-Thru and Closed End Connectors**

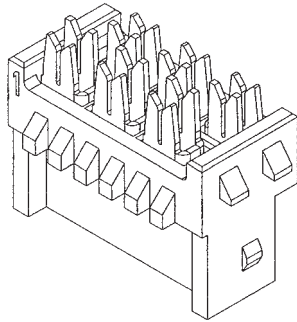

**Material and Finish**

**Housing** — UL 94V-2 rated, thermo-plastic

**Contacts** — Phosphor bronze; .000100 [0.00254] min. tin in wire termination area, over .000050 [0.00127] min. nickel; choice on mating end: .000100 [0.00254] min. tin or .000030 [0.00076] gold or .000015 [0.00038] gold, over .000050 [0.00127] min. nickel

**Color Coding by Wire Size for UL94V-0 Connectors**

- 26 AWG** — Blue
- 28 AWG** — Green
- 30 AWG** — Brown

For Strain Relief Covers see page 6.  
For mating Headers see pages 9 and 10.  
For Mateability Guide, see matrixes on page 4.

**Receptacle Assemblies — Ribbon Cable**

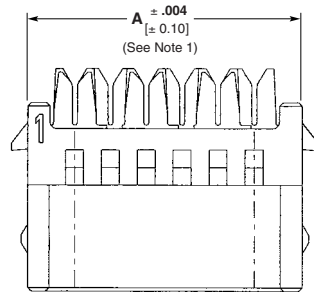

**Notes:**

1. To determine connector overall length (dim. A), multiply .050 x the number of circuits and add .082. Example: .050 x 10 circuits equals 0.50 + .082 = .582 [14.78].
2. Strain relief covers shown on page 6 are required and sold as part of the Connector Kit.
3. Stranded UL Style 1061 or equivalent wire is recommended.
4. Unless otherwise stated all tolerances (except plating) to be ±.005 [±0.13].
5. Consult Product Drawing for RoHS Compliant information.

**Connector Kits — Ribbon Cable**

**Connector Kit Ordering Information**

Connector Kit consists of Receptacle Assembly and Strain Relief Cover.

Base part number prefixes and suffixes indicate the number of circuit positions, for example: Base part number 1445359

- 2 position = 0-1445359-2 and
- 28 position = 2-1445359-8

**Note:** Tin-plated connectors and headers in even position sizes from 2–12 and 18 are stocked parts; all other position sizes and products with gold-plated contacts are Make To Order.

**Base Part Numbers**

| Connector Type & Wire Size                 | Feed-Thru               |                 | Closed End              |                 |
|--|-------------------------|-----------------|-------------------------|-----------------|
|  | Connector Kit Part Nos. | No. of Circuits | Connector Kit Part Nos. | No. of Circuits |
| <b>Tin Plated</b>                          |                         |                 |                         |                 |
| <b>26 AWG</b><br>0.12–0.15 mm <sup>2</sup> | 1445359                 | 2–28            | 1445368                 | 2–28            |
| <b>28 AWG</b><br>0.08–0.09 mm <sup>2</sup> | 1445362                 | 2–28            | 1445371                 | 2–28            |
| <b>30 AWG</b><br>0.05–0.06 mm <sup>2</sup> | 1445365                 | 2–28            | 1445374                 | 2–28            |
| <b>.000030 [0.00076] Gold Plated</b>       |                         |                 |                         |                 |
| <b>26 AWG</b><br>0.12–0.15 mm <sup>2</sup> | 1445361                 | 2–28            | 1445370                 | 2–28            |
| <b>28 AWG</b><br>0.08–0.09 mm <sup>2</sup> | 1445364                 | 2–28            | 1445373                 | 2–28            |
| <b>30 AWG</b><br>0.05–0.06 mm <sup>2</sup> | 1445367                 | 2–28            | 1445376                 | 2–28            |
| <b>.000015 [0.00038] Gold Plated</b>       |                         |                 |                         |                 |
| <b>26 AWG</b><br>0.12–0.15 mm <sup>2</sup> | 1445360                 | 2–28            | 1445369                 | 2–28            |
| <b>28 AWG</b><br>0.08–0.09 mm <sup>2</sup> | 1445363                 | 2–28            | 1445372                 | 2–28            |
| <b>30 AWG</b><br>0.05–0.06 mm <sup>2</sup> | 1445366                 | 2–28            | 1445375                 | 2–28            |



**MTA-50 IDC Connectors and Headers (Continued)**

**Connector Kits — Ribbon Cable (Continued)**

**Strain Relief Covers**

**Material and Finish**  
**Strain Relief Cover** — UL 94V-0 rated, thermoplastic, black



**Feed-Thru**

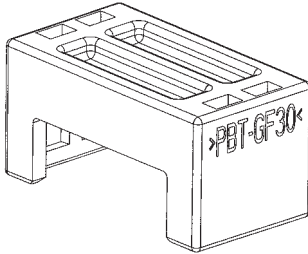

Feed-Thru

**Closed End**

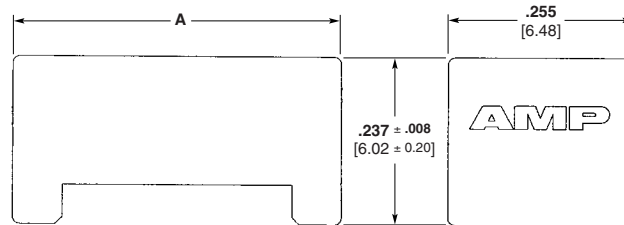
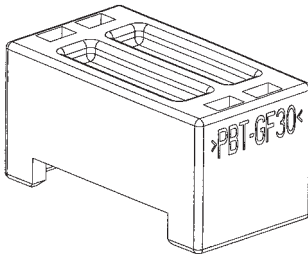

Closed End

**Feed-Thru and Closed End**

| No. of Circuits | Dim. A        | No. of Circuits | Dim. A         |
|-----------------|---------------|-----------------|----------------|
| 2               | .260<br>6.60  | 16              | .960<br>24.38  |
| 3               | .310<br>7.87  | 17              | 1.010<br>25.65 |
| 4               | .360<br>9.14  | 18              | 1.060<br>26.92 |
| 5               | .410<br>10.41 | 19              | 1.110<br>28.19 |
| 6               | .460<br>11.68 | 20              | 1.160<br>29.46 |
| 7               | .510<br>12.95 | 21              | 1.210<br>30.73 |
| 8               | .560<br>14.22 | 22              | 1.260<br>32.00 |
| 9               | .610<br>15.49 | 23              | 1.310<br>33.27 |
| 10              | .660<br>16.76 | 24              | 1.360<br>34.54 |
| 11              | .710<br>18.03 | 25              | 1.410<br>35.81 |
| 12              | .760<br>19.30 | 26              | 1.460<br>37.08 |
| 13              | .810<br>20.57 | 27              | 1.510<br>38.35 |
| 14              | .860<br>21.84 | 28              | 1.560<br>39.62 |
| 15              | .910<br>23.11 |                 |                |

MTA-50  
.050 [1.27]

**MTA-50 IDC Connectors and Headers (Continued)**

MTA-50  
.050 [1.27]

**Feed-Thru and Closed End Connectors**



**Receptacle Assemblies — Discrete Wire**



**Material and Finish**

**Housing** — UL 94V-2 rated, thermo-plastic

**Contacts** — Phosphor bronze; .000100 [0.00254] min. tin in wire termination area, over .000050 [0.00127] min. nickel; choice on mating end: .000100 [0.00254] min. tin or .000030 [0.00076] gold or .000015 [0.00038] gold, over .000050 [0.00127] min. nickel

**Color Coding by Wire Size for UL94V-0 Connectors**

- 26 AWG — Blue
- 28 AWG — Green
- 30 AWG — Brown



**Notes:**

1. To determine connector overall length (dim. A), multiply .050 x the number of circuits and add .082. Example: .050 x 10 circuits equals 0.50 + .082 = .582 [14.78].
2. Strain relief covers shown on page 8 are required and sold as part of the Connector Kit.
3. Stranded UL Style 1061 or equivalent wire is recommended.
4. Unless otherwise stated all tolerances (except plating) to be ±.005 [±0.13].
5. Consult Product Drawing for RoHS Compliant information.

For Strain Relief Covers see page 8.  
For mating Headers see pages 9 and 10.  
For Mateability Guide, see matrixes on page 4.

**Connector Kits — Discrete Wire**

**Connector Kit Ordering Information**

Connector Kit consists of Receptacle Assembly and Strain Relief Cover.

Base part number prefixes and suffixes indicate the number of circuit positions, for example: Base part number 1445341

- 2 position = 0-1445341-2 and
- 28 position = 2-1445341-8

**Note:** Tin-plated connectors and headers in even position sizes from 2–12 and 18 are stocked parts; all other position sizes and products with gold-plated contacts are Make To Order.

**Base Part Numbers**

| Connector Type & Wire Size           | Feed-Thru               |                 | Closed End              |                 |
|--------------------------------------|-------------------------|-----------------|-------------------------|-----------------|
|                                      | Connector Kit Part Nos. | No. of Circuits | Connector Kit Part Nos. | No. of Circuits |
| <b>Tin Plated</b>                    |                         |                 |                         |                 |
| 26 AWG<br>0.12–0.15 mm <sup>2</sup>  | 1445341                 | 2–28            | 1445350                 | 2–28            |
| 28 AWG<br>0.08–0.09 mm <sup>2</sup>  | 1445344                 | 2–28            | 1445353                 | 2–28            |
| 30 AWG<br>0.05–0.06 mm <sup>2</sup>  | 1445347                 | 2–28            | 1445356                 | 2–28            |
| <b>.000030 [0.00076] Gold Plated</b> |                         |                 |                         |                 |
| 26 AWG<br>0.12–0.15 mm <sup>2</sup>  | 1445343                 | 2–28            | 1445352                 | 2–28            |
| 28 AWG<br>0.08–0.09 mm <sup>2</sup>  | 1445346                 | 2–28            | 1445355                 | 2–28            |
| 30 AWG<br>0.05–0.06 mm <sup>2</sup>  | 1445349                 | 2–28            | 1445358                 | 2–28            |
| <b>.000015 [0.00038] Gold Plated</b> |                         |                 |                         |                 |
| 26 AWG<br>0.12–0.15 mm <sup>2</sup>  | 1445342                 | 2–28            | 1445351                 | 2–28            |
| 28 AWG<br>0.08–0.09 mm <sup>2</sup>  | 1445345                 | 2–28            | 1445354                 | 2–28            |
| 30 AWG<br>0.05–0.06 mm <sup>2</sup>  | 1445348                 | 2–28            | 1445357                 | 2–28            |



**MTA-50 IDC Connectors and Headers (Continued)**

**Connector Kits —  
Discrete Wire (Continued)**

**Strain Relief Covers**

**Material and Finish**  
**Strain Relief Cover** — UL 94V-0  
rated, thermoplastic, black

**Feed-Thru**



**Closed End**



**Feed-Thru**



**Closed End**

**Feed-Thru and Closed End**

| No. of Circuits | Dim. A        | No. of Circuits | Dim. A         |
|-----------------|---------------|-----------------|----------------|
| 2               | .260<br>6.60  | 16              | .960<br>24.38  |
| 3               | .310<br>7.87  | 17              | 1.010<br>25.65 |
| 4               | .360<br>9.14  | 18              | 1.060<br>26.92 |
| 5               | .410<br>10.41 | 19              | 1.110<br>28.19 |
| 6               | .460<br>11.68 | 20              | 1.160<br>29.46 |
| 7               | .510<br>12.95 | 21              | 1.210<br>30.73 |
| 8               | .560<br>14.22 | 22              | 1.260<br>32.00 |
| 9               | .610<br>15.49 | 23              | 1.310<br>33.27 |
| 10              | .660<br>16.76 | 24              | 1.360<br>34.54 |
| 11              | .710<br>18.03 | 25              | 1.410<br>35.81 |
| 12              | .760<br>19.30 | 26              | 1.460<br>37.08 |
| 13              | .810<br>20.57 | 27              | 1.510<br>38.35 |
| 14              | .860<br>21.84 | 28              | 1.560<br>39.62 |
| 15              | .910<br>23.11 |                 |                |

MTA-50  
.050 [1.27]



**MTA-50 IDC Connectors and Headers (Continued)**

**Through-Hole Header Assemblies**

**Vertical**



**Material and Finish**

**Housing** — UL 94V-0 rated, thermo-plastic, black

**Contacts** — Brass, .000100 [0.00254] min. tin over .000050 [0.00127] min. nickel on solder legs; choice on mating end:  
.000100 [0.00254] min. tin or  
.000030 [0.00076] gold or  
.000015 [0.00038] gold, over  
.000050 [0.00127] min. nickel



**Note:** To determine header overall length (dim. A), multiply .050 x the number of circuits and add .150. Example: .050 x 6 circuits equals .300 + .150 = .450 [11.43].



**Recommended Mounting Hole Size and Pattern for .062 [1.57] Thick PC Board**

\* 6-circuit Dim. shown, refer to Product Drawing for actual PCB Dimensions and RoHS Compliant information.

**Base Part Numbers**

| Through-Hole   |              |
|--|--------------|
| Header Part Nos.                                       | No. of Posts |
| <b>Standard UL 94V-0, Tin Plated</b>                   |              |
| 1445120  | 2-28         |
| <b>Standard UL 94V-0 .000030 [0.00076] Gold Plated</b> |              |
| 1445125  | 2-28         |
| <b>Standard UL 94V-0 .000015 [0.00038] Gold Plated</b> |              |
| 1445123  | 2-28         |

**Right-Angle**



For mating Connector Kits see pages 5 through 8.

For mateability options, see matrixes on page 4.

**Header Ordering Information**

Base part number prefixes and suffixes indicate the number of circuit positions, for example: Base part number 1445120

2 position = 0-1445120-2  
and  
28 position = 2-1445120-8

**Note:** Tin-plated connectors and headers in even position sizes from 2-12 and 18 are stocked parts; all other position sizes and products with gold-plated contacts are Make To Order.



**Recommended Mounting Hole Size and Pattern for .062 [1.57] Thick PC Board**

\* 6-circuit Dim. shown, refer to Product Drawing for actual PCB Dimensions and RoHS Compliant information.

**Base Part Numbers**

| Through-Hole   |              |
|--|--------------|
| Header Part Nos.                                       | No. of Posts |
| <b>Standard UL 94V-0, Tin Plated</b>                   |              |
| 1445169  | 2-28         |
| <b>Standard UL 94V-0 .000030 [0.00076] Gold Plated</b> |              |
| 1445171  | 2-28         |
| <b>Standard UL 94V-0 .000015 [0.00038] Gold Plated</b> |              |
| 1445170  | 2-28         |

**MTA-50 IDC Connectors and Headers (Continued)**

**Surface Mount Header Assemblies**

**Vertical**



**Material and Finish**

**Housing** — UL 94V-0 rated, thermo-plastic, black

**Contacts** — Brass, .000100 [0.00254] min. tin over .000050 [0.00127] min. nickel on solder pads; choice on mating end:

.000100 [0.00254] min. tin or  
.000030 [0.00076] gold or  
.000015 [0.00038] gold, over  
.000050 [0.00127] min. nickel

**Boardlock** — Phosphor bronze, tin plated .000100 [0.000254] min. over .000050 [0.00127] min. nickel



**Note:** To determine header overall length (dim. A), multiply .050 x the number of circuits and add .150. Example: .050 x 6 circuits equals .300 + .150 = .450 [11.43].



**Recommended PC Board Layout**  
for use with .010 [0.25] Thick Stencil

\* 6-circuit Dim. shown, refer to Product Drawing for actual PCB Dimensions and RoHS Compliant information.

**Base Part Numbers**

| Surface Mount  |              |
|--|--------------|
| Header Part Nos.                                       | No. of Posts |
| <b>Standard UL 94V-0, Tin Plated</b>                   |              |
| 1445121  | 2-28         |
| <b>Standard UL 94V-0 .000030 [0.00076] Gold Plated</b> |              |
| 1445126  | 2-28         |
| <b>Standard UL 94V-0 .000015 [0.00038] Gold Plated</b> |              |
| 1445124  | 2-28         |

**Note:** All SMT product is pre-packaged in standard tape and reel format.

**Right-Angle**



For mating Connector Kits see pages 5 through 8.

For mateability options, see matrixes on page 4.

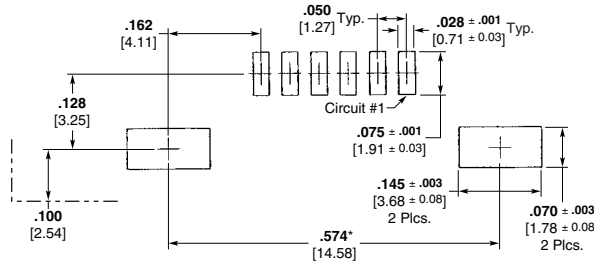

**Recommended PC Board Layout**  
for use with .010 [0.25] Thick Stencil

\* 6-circuit Dim. shown, refer to Product Drawing for actual PCB Dimensions and RoHS Compliant information.

**Base Part Numbers**

| Surface Mount  |              |
|--|--------------|
| Header Part Nos.                                       | No. of Posts |
| <b>Standard UL 94V-0, Tin Plated</b>                   |              |
| 1445172  | 2-28         |
| <b>Standard UL 94V-0 .000030 [0.00076] Gold Plated</b> |              |
| 1445174  | 2-28         |
| <b>Standard UL 94V-0 .000015 [0.00038] Gold Plated</b> |              |
| 1445173  | 2-28         |

**Header Ordering Information**

Base part number prefixes and suffixes indicate the number of circuit positions, for example: Base part number 1445121

2 position = 0-1445121-2  
and  
28 position = 2-1445121-8

**Note:** Tin-plated connectors and headers in even position sizes from 2-12 and 18 are stocked parts; all other position sizes and products with gold-plated contacts are Make To Order.

MTA-50  
.050 [1.27]

## .100 [2.54] Centerline MTA-100 IDC Connectors and Headers

### Product Facts

- Connectors and headers for 2 through 28 positions; wire sizes of 22, 24, 26 and 28 AWG [0.4-0.08 mm<sup>2</sup>]
- Wire-to-Post Connectors preloaded with dual beam contacts
- Connectors and headers, except shrouded headers, are end-to-end stackable
- Connector styles include both closed end and feed-thru connectors with locking ramps, with and without polarizing tabs
- Molded ribs on housing do not allow reverse mating
- Posted connectors for 2 through 19 positions
- Connectors preloaded with IDC contacts
- All contacts are slotted for insulation displacement (IDC) terminal technique
- Contacts are lubricated for fretting corrosion protection
- Benefits derived from the MTA-100 system include increased quality and ease of handling such as —
  - One-step assembly
  - No wire stripping
  - No contact damage
  - Reduced wiring errors
  - Simpler tooling
  - Simple maintenance and repair
- Meets the material requirements of Table 23.1 of UL1410 Standards for Television Receiver and Video Products (wire-to-post connectors only)
- Recognized under the Component Program of Underwriters Laboratories Inc., File No. E28476 
- Certified by Canadian Standards Association, File No. LR7189 

### Technical Documents

#### Product Specification

108-1050 MTA-100 Connectors

#### Application Specifications

114-1019 MTA-100 Connectors

114-1031 MTA-100 Ribbon Cable Assembly



MTA-100 connectors accept discrete and ribbon cable wire sizes ranging from 22–28 AWG [0.4–0.08 mm<sup>2</sup>] with maximum insulation outside diameter of .060 [1.52] for terminating single wire and .050 [1.27] for mass termination of wires. Tin plated solid, fused stranded, or stranded (7 strands) wire with PVC insulation can be used on 22–28 AWG [0.4–0.9 mm<sup>2</sup>] MTA-100 connectors and 19 stranded wire on 22–24 AWG [0.4–0.2 mm<sup>2</sup>] MTA-100 connectors. Only

one wire to be terminated into an IDC contact slot.

The wire-to-post connector housing material is flame retardant thermoplastic, either UL94V-2 or UL94V-0 rated.

A full line of .100 [2.54] centerline headers completes the system. Headers are available with straight or right-angle posts, in flat, polarized or friction lock styles. Headers are available in 2 through 28 positions. Shrouded headers are available in 2 through 14 positions.

### Performance Data\*

**Voltage Rating** — 250 vac

**Current Rating** — 5 amp max.

**Low-Level Resistance** — 6 mΩ max. initial

**Dielectric Withstanding Voltage** — 750 vac/1 min.

**Insulation Resistance** — 5000 MΩ min. initial

**Operating Temperature** — –55° C to +105° C

**Note:** Refer to page 70 for approved wire listings.

\*Refer to the Product Specification for additional electrical, mechanical and environmental performance tests and requirements.



### MTA-100 Connector/Header Mateability Guide (Continued)

This matrix has been prepared to assist you, our customer, in defining the correct mating halves for the MTA-100 header and connector combination. Where a "Y" is indicated the combination is a valid mating pair. Where an "N" is indicated the combination is not acceptable for mating.

**Matrix for .000030  
[0.00076] Gold Plated  
Part Numbers**

| Connectors | Headers |        |        |        |        |        |        |        |        |        |        |        |        |        |        |        |        |        |        |        |        |        |        |        |        |        |
|------------|---------|--------|--------|--------|--------|--------|--------|--------|--------|--------|--------|--------|--------|--------|--------|--------|--------|--------|--------|--------|--------|--------|--------|--------|--------|--------|
|            | 641211  | 641212 | 641213 | 641214 | 641215 | 641216 | 644487 | 644489 | 644884 | 644885 | 644886 | 644887 | 644896 | 644897 | 644898 | 647108 | 647109 | 647114 | 647116 | 647117 | 647168 | 647626 | 647624 | 647534 | 744047 | 744163 |
| 641237     | Y       | Y      | Y      | Y      | Y      | Y      | Y      | Y      | Y      | Y      | Y      | Y      | N      | N      | N      | Y      | Y      | Y      | Y      | Y      | Y      | Y      | Y      | Y      | Y      | Y      |
| 641238     | Y       | Y      | Y      | Y      | Y      | Y      | Y      | Y      | Y      | Y      | Y      | Y      | N      | N      | N      | Y      | Y      | Y      | Y      | Y      | Y      | Y      | Y      | Y      | Y      | Y      |
| 641239     | Y       | Y      | Y      | Y      | Y      | Y      | Y      | Y      | Y      | Y      | Y      | Y      | N      | N      | N      | Y      | Y      | Y      | Y      | Y      | Y      | Y      | Y      | Y      | Y      | Y      |
| 641240     | Y       | Y      | Y      | Y      | Y      | Y      | Y      | Y      | Y      | Y      | Y      | Y      | N      | N      | N      | Y      | Y      | Y      | Y      | Y      | Y      | Y      | Y      | Y      | Y      | Y      |
| 641241     | Y       | Y      | Y      | Y      | Y      | Y      | Y      | Y      | Y      | Y      | Y      | Y      | N      | N      | N      | Y      | Y      | Y      | Y      | Y      | Y      | Y      | Y      | Y      | Y      | Y      |
| 641242     | Y       | Y      | Y      | Y      | Y      | Y      | Y      | Y      | Y      | Y      | Y      | Y      | N      | N      | N      | Y      | Y      | Y      | Y      | Y      | Y      | Y      | Y      | Y      | Y      | Y      |
| 641243     | Y       | Y      | Y      | Y      | Y      | Y      | Y      | Y      | Y      | Y      | Y      | Y      | N      | N      | N      | Y      | Y      | Y      | Y      | Y      | Y      | Y      | Y      | Y      | Y      | Y      |
| 641244     | Y       | Y      | Y      | Y      | Y      | Y      | Y      | Y      | Y      | Y      | Y      | Y      | N      | N      | N      | Y      | Y      | Y      | Y      | Y      | Y      | Y      | Y      | Y      | Y      | Y      |
| 644020     | Y       | Y      | Y      | Y      | Y      | Y      | Y      | Y      | Y      | Y      | Y      | Y      | N      | N      | N      | Y      | Y      | Y      | Y      | Y      | Y      | Y      | Y      | Y      | Y      | Y      |
| 644042     | Y       | Y      | Y      | Y      | Y      | Y      | Y      | Y      | Y      | Y      | Y      | Y      | N      | N      | N      | Y      | Y      | Y      | Y      | Y      | Y      | Y      | Y      | Y      | Y      | Y      |
| 644043     | Y       | Y      | Y      | Y      | Y      | Y      | Y      | Y      | Y      | Y      | Y      | Y      | N      | N      | N      | Y      | Y      | Y      | Y      | Y      | Y      | Y      | Y      | Y      | Y      | Y      |
| 644044     | Y       | Y      | Y      | Y      | Y      | Y      | Y      | Y      | Y      | Y      | Y      | Y      | N      | N      | N      | Y      | Y      | Y      | Y      | Y      | Y      | Y      | Y      | Y      | Y      | Y      |
| 644702     | Y       | Y      | Y      | Y      | Y      | Y      | Y      | Y      | Y      | Y      | Y      | Y      | N      | N      | N      | Y      | Y      | Y      | Y      | Y      | Y      | Y      | Y      | Y      | Y      | Y      |
| 644726     | Y       | Y      | Y      | Y      | Y      | Y      | Y      | Y      | Y      | Y      | Y      | Y      | N      | N      | N      | Y      | Y      | Y      | Y      | Y      | Y      | Y      | Y      | Y      | Y      | Y      |
| *1375820   | Y       | Y      | Y      | Y      | Y      | Y      | N      | N      | Y      | Y      | Y      | Y      | Y      | Y      | Y      | Y      | Y      | Y      | Y      | Y      | Y      | Y      | Y      | Y      | Y      | Y      |

**Matrix for .000015  
[0.00038] Gold Plated  
Part Numbers**

| Connectors | Headers |        |        |        |        |        |        |        |        |        |        |        |        |        |        |        |        |        |        |        |         |   |   |   |   |   |
|------------|---------|--------|--------|--------|--------|--------|--------|--------|--------|--------|--------|--------|--------|--------|--------|--------|--------|--------|--------|--------|---------|---|---|---|---|---|
|            | 641122  | 641123 | 641124 | 641125 | 641126 | 641127 | 644888 | 644889 | 644890 | 644891 | 647075 | 647076 | 647078 | 647079 | 647107 | 647167 | 647467 | 647625 | 647627 | 647533 | 1744074 |   |   |   |   |   |
| 641190     | Y       | Y      | Y      | Y      | Y      | Y      | Y      | Y      | Y      | Y      | Y      | Y      | Y      | Y      | Y      | Y      | Y      | Y      | Y      | Y      | Y       | Y | Y | Y | Y |   |
| 641191     | Y       | Y      | Y      | Y      | Y      | Y      | Y      | Y      | Y      | Y      | Y      | Y      | Y      | Y      | Y      | Y      | Y      | Y      | Y      | Y      | Y       | Y | Y | Y | Y |   |
| 641192     | Y       | Y      | Y      | Y      | Y      | Y      | Y      | Y      | Y      | Y      | Y      | Y      | Y      | Y      | Y      | Y      | Y      | Y      | Y      | Y      | Y       | Y | Y | Y | Y |   |
| 641193     | Y       | Y      | Y      | Y      | Y      | Y      | Y      | Y      | Y      | Y      | Y      | Y      | Y      | Y      | Y      | Y      | Y      | Y      | Y      | Y      | Y       | Y | Y | Y | Y |   |
| 641198     | Y       | Y      | Y      | Y      | Y      | Y      | Y      | Y      | Y      | Y      | Y      | Y      | Y      | Y      | Y      | Y      | Y      | Y      | Y      | Y      | Y       | Y | Y | Y | Y |   |
| 641199     | Y       | Y      | Y      | Y      | Y      | Y      | Y      | Y      | Y      | Y      | Y      | Y      | Y      | Y      | Y      | Y      | Y      | Y      | Y      | Y      | Y       | Y | Y | Y | Y |   |
| 641200     | Y       | Y      | Y      | Y      | Y      | Y      | Y      | Y      | Y      | Y      | Y      | Y      | Y      | Y      | Y      | Y      | Y      | Y      | Y      | Y      | Y       | Y | Y | Y | Y |   |
| 641201     | Y       | Y      | Y      | Y      | Y      | Y      | Y      | Y      | Y      | Y      | Y      | Y      | Y      | Y      | Y      | Y      | Y      | Y      | Y      | Y      | Y       | Y | Y | Y | Y |   |
| 644038     | Y       | Y      | Y      | Y      | Y      | Y      | Y      | Y      | Y      | Y      | Y      | Y      | Y      | Y      | Y      | Y      | Y      | Y      | Y      | Y      | Y       | Y | Y | Y | Y |   |
| 644040     | Y       | Y      | Y      | Y      | Y      | Y      | Y      | Y      | Y      | Y      | Y      | Y      | Y      | Y      | Y      | Y      | Y      | Y      | Y      | Y      | Y       | Y | Y | Y | Y |   |
| 647477     | Y       | Y      | Y      | Y      | Y      | Y      | Y      | Y      | Y      | Y      | Y      | Y      | Y      | Y      | Y      | Y      | Y      | Y      | Y      | Y      | Y       | Y | Y | Y | Y |   |
| 647480     | Y       | Y      | Y      | Y      | Y      | Y      | Y      | Y      | Y      | Y      | Y      | Y      | Y      | Y      | Y      | Y      | Y      | Y      | Y      | Y      | Y       | Y | Y | Y | Y |   |
| *1375820   | N       | N      | N      | N      | N      | N      | N      | N      | N      | N      | N      | N      | N      | N      | N      | N      | N      | N      | N      | N      | N       | N | Y | Y | Y | Y |
| 1744020    | Y       | Y      | Y      | Y      | Y      | Y      | Y      | Y      | Y      | Y      | Y      | Y      | Y      | Y      | Y      | Y      | Y      | Y      | Y      | Y      | Y       | Y | Y | Y | Y |   |

\*Select contact plating to match header plating.

MTA-100  
.100 [2.54]



**MTA-100 IDC Connectors—Closed End and Feed-Thru**

**Material and Finish**

**Housing**—UL94V-2 rated, nylon, see below for color; or UL94V-0 rated, nylon, black

**Contacts**—Phosphor bronze, post tin plated, .000030 [0.00076] or .000015 [0.00038] post gold-plated over nickel

**Color Coding by Wire Size for UL94V-2 Connectors**

- 28 AWG—Green
- 26 AWG—Blue
- 24 AWG—White
- 22 AWG—Red

All wire sizes in UL94V-0—Black

For mateability options, see matrix on pages 12 and 13.

For mating half visuals, see pages 20 thru 30.

**Notes:**

1. Refer to pages 70-74 for approved wire listing.
2. For strain reliefs and dust covers, see page 16.
3. For keying plugs, see page 17.
4. Other circuit sizes are available upon request. Minimums may apply.
5. Connector circuits can be molded closed for keying purposes. Minimums may apply.
6. Where no part numbers appear in the chart, parts can be made available upon request. Minimums may apply.
7. To determine connector overall length (dim. A), multiply .100 x the number of circuits. Example: .100 x 10 circuits equals 1.000 inch [25.4 mm].

**Closed End Connectors**



Without Polarizing Tabs



With Polarizing Tabs

**Feed-Thru Connectors**



Without Polarizing Tabs



With Polarizing Tabs

MTA-100  
.100 [2.54]

### Connector Ordering Information

The "Base Part Numbers" Chart at right shows the base part number, and their RoHS (Restrictions on Certain Hazardous Substances) Compliant (lead free) equivalent available for the described connectors.

Prefixes and suffixes are determined by the number of circuit positions in the connector. For example, the complete part number for a 10-position closed end connector without polarizing tabs for 22 AWG wire would be:

Base number **640440** plus prefix-and-suffix  
**4- -0**

The correct ordering number is **4-640440-0**

All part numbers are the RoHS equivalent version. Example:

| No. of Pos. | Lead Free RoHS Prefix/Suffix |
|-------------|------------------------------|
| 2           | 3-640440-2                   |
| 3           | 3-640440-3                   |
| 4           | 3-640440-4                   |
| 5           | 3-640440-5                   |
| 6           | 3-640440-6                   |
| 7           | 3-640440-7                   |
| 8           | 3-640440-8                   |
| 9           | 3-640440-9                   |
| 10          | 4-640440-0                   |
| 11          | 4-640440-1                   |
| 12          | 4-640440-2                   |
| 13          | 4-640440-3                   |
| 14          | 4-640440-4                   |
| 15          | 4-640440-5                   |
| 16          | 4-640440-6                   |
| 17          | 4-640440-7                   |
| 18          | 4-640440-8                   |
| 19          | 4-640440-9                   |
| 20          | 5-640440-0                   |
| 21          | 5-640440-1                   |
| 22          | 5-640440-2                   |
| 23          | 5-640440-3                   |
| 24          | 5-640440-4                   |
| 25          | 5-640440-5                   |
| 26          | 5-640440-6                   |
| 27          | 5-640440-7                   |
| 28          | 5-640440-8                   |

**Note:** All RoHS equivalent part numbers may not be available upon catalog release. If the number you need is not available, please contact Product Engineering to expedite your request.

## MTA-100 IDC Connectors—Closed End and Feed-Thru (Continued)

### Base Part Numbers

| Connector Type & Wire Size  | Closed End          |              |                      |              | Feed-Thru           |              |                     |              |
|---|---------------------|--------------|----------------------|--------------|---------------------|--------------|---------------------|--------------|
|   | Without Tabs        |              | With Tabs            |              | Without Tabs        |              | With Tabs           |              |
|   | Connector Part Nos. | RoHS Equiv.  | Connector Part Nos.  | RoHS Equiv.  | Connector Part Nos. | RoHS Equiv.  | Connector Part Nos. | RoHS Equiv.  |
| <b>Standard UL94V-2, Tin Plated</b>   |                     |              |                      |              |                     |              |                     |              |
| <b>22 AWG</b><br>0.3–0.4 mm <sup>2</sup>  | 640440              | <b>32–58</b> | 643813               | <b>32–58</b> | 640620              | <b>32–58</b> | 644540 <sup>1</sup> | <b>32–45</b> |
| <b>24 AWG</b><br>0.2 mm <sup>2</sup>  | 640441              | <b>32–58</b> | 643814               | <b>32–58</b> | 640621              | <b>32–58</b> | 644563 <sup>1</sup> | <b>32–54</b> |
| <b>26 AWG</b><br>0.12–0.15 mm <sup>2</sup>  | 640442              | <b>32–58</b> | 643815               | <b>32–58</b> | 640622              | <b>32–58</b> | 644564 <sup>1</sup> | <b>32–45</b> |
| <b>28 AWG</b><br>0.08–0.09 mm <sup>2</sup>  | 640443              | <b>32–58</b> | 643816               | <b>32–58</b> | 640623              | <b>32–58</b> | 644565 <sup>1</sup> | <b>32–45</b> |
| <b>Tape Mounted on Reel UL94V-2, Tin Plated</b>   |                     |              |                      |              |                     |              |                     |              |
| <b>22 AWG</b><br>0.3–0.4 mm <sup>2</sup>  | 640468              | <b>32–58</b> | 644511               | <b>42–68</b> | 641311              | <b>32–58</b> | —                   | —            |
| <b>24 AWG</b><br>0.2 mm <sup>2</sup>  | 640469              | <b>32–58</b> | 644512               | <b>32–58</b> | 641312              | <b>32–58</b> | —                   | —            |
| <b>26 AWG</b><br>0.12–0.15 mm <sup>2</sup>  | 640470              | <b>32–58</b> | 644513               | <b>32–58</b> | 641313              | <b>32–58</b> | —                   | —            |
| <b>28 AWG</b><br>0.08–0.09 mm <sup>2</sup>  | 640471              | <b>32–58</b> | 644514               | <b>32–58</b> | 641314              | <b>32–58</b> | —                   | —            |
| <b>Standard UL94V-2, .000030 [0.00076] Gold Plated</b>  |                     |              |                      |              |                     |              |                     |              |
| <b>22 AWG</b><br>0.3–0.4 mm <sup>2</sup>  | 641237              | <b>32–58</b> | 644042               | <b>32–58</b> | 641241              | <b>32–58</b> | 644702 <sup>1</sup> | <b>32–45</b> |
| <b>24 AWG</b><br>0.2 mm <sup>2</sup>  | 641238              | <b>32–58</b> | 644020               | <b>32–58</b> | 641242              | <b>32–58</b> | —                   | —            |
| <b>26 AWG</b><br>0.12–0.15 mm <sup>2</sup>  | 641239              | <b>32–58</b> | 644043 <sup>1</sup>  | <b>32–44</b> | 641243              | <b>32–58</b> | 644726 <sup>1</sup> | <b>32–45</b> |
| <b>28 AWG</b><br>0.8–0.9 mm <sup>2</sup>  | 641240              | <b>32–58</b> | 644044 <sup>1</sup>  | <b>32–44</b> | 641244              | <b>32–58</b> | —                   | —            |
| <b>Standard UL94V-2, .000015 [0.00038] Gold Plated</b>  |                     |              |                      |              |                     |              |                     |              |
| <b>22 AWG</b><br>0.3–0.4 mm <sup>2</sup>  | 641190              | <b>32–58</b> | 644038 <sup>1</sup>  | <b>32–44</b> | 641198              | <b>32–58</b> | 647477              | <b>32–46</b> |
| <b>24 AWG</b><br>0.2 mm <sup>2</sup>  | 641191              | <b>32–58</b> | 1744020 <sup>1</sup> | <b>32–44</b> | 641199              | <b>32–58</b> | —                   | —            |
| <b>26 AWG</b><br>0.12–0.15 mm <sup>2</sup>  | 641192              | <b>32–58</b> | 644040 <sup>1</sup>  | <b>32–44</b> | 641200              | <b>32–58</b> | 647480              | <b>32–43</b> |
| <b>28 AWG</b><br>0.08–0.09 mm <sup>2</sup>  | 641193              | <b>32–58</b> | —                    | —            | 641201              | <b>32–58</b> | —                   | —            |
| <b>LED*, UL94V-2, Tin Plated (See Note 1)</b>   |                     |              |                      |              |                     |              |                     |              |
| <b>22 AWG</b><br>0.3–0.4 mm <sup>2</sup>  | 641534              | <b>32–33</b> | —                    | —            | 641653              | <b>32–33</b> | —                   | —            |
| <b>24 AWG</b><br>0.2 mm <sup>2</sup>  | 641535              | <b>32–33</b> | 644795               | <b>32–33</b> | 641654              | <b>32–33</b> | —                   | —            |
| <b>26 AWG</b><br>0.12–0.15 mm <sup>2</sup>  | 641536              | <b>32–33</b> | —                    | —            | 641655              | <b>32–33</b> | —                   | —            |
| <b>28 AWG</b><br>0.08–0.09 mm <sup>2</sup>  | 641537              | <b>32–33</b> | —                    | —            | 641656              | <b>32–33</b> | —                   | —            |
| <b>Standard UL94V-0, Tin Plated (Gold is available, minimums may apply.) (Black in color)</b> |                     |              |                      |              |                     |              |                     |              |
| <b>22 AWG</b><br>0.3–0.4 mm <sup>2</sup>  | 643498 <sup>1</sup> | <b>32–45</b> | 644083 <sup>1</sup>  | <b>32–45</b> | 644575 <sup>1</sup> | <b>32–45</b> | 644578 <sup>1</sup> | <b>32–45</b> |
| <b>24 AWG</b><br>0.2 mm <sup>2</sup>  | 644574 <sup>1</sup> | <b>32–45</b> | 644312 <sup>1</sup>  | <b>32–45</b> | 644576 <sup>1</sup> | <b>32–45</b> | 644579 <sup>1</sup> | <b>32–45</b> |
| <b>26 AWG</b><br>0.12–0.15 mm <sup>2</sup>  | 643828 <sup>1</sup> | <b>32–45</b> | 644313 <sup>1</sup>  | <b>32–45</b> | 644577 <sup>1</sup> | <b>32–45</b> | 644497 <sup>1</sup> | <b>32–45</b> |

\*LED connectors are designed to mate with .014–.020 [0.36–0.51] diameter posts or square leads.

<sup>1</sup> Other circuit sizes are available upon request. Minimums may apply.

<sup>2</sup> Tape mounted.

**Note:** Blocked circuit configurations are available. Contact product engineer or product manager for details. Minimums may apply.

**MTA-100 IDC Connector Accessories**

**Covers**

**Material (RoHS Compliant)**

**Strain Relief Cover** — UL94V-2 rated, nylon, white

**Dust Covers** — UL94V-0 rated, polyester, white

**Closed End Strain Relief Covers**



**Closed End Dust Covers**



**Feed-Thru Strain Relief Covers**



**Feed-Thru Dust Covers**



**Cover Ordering Information**

The "Base Part Numbers" Chart at right shows the base part number and number of circuits available for the described cover.

Prefixes and suffixes are determined by the number of circuit positions in the cover. For example, the complete part number for a 10-position closed end strain relief cover would be:

Base number **643075** plus prefix-and-suffix

**1- -0**

The correct ordering number is

**1-643075-0**

**Base Part Numbers**

| Closed End           |                 |                 |                 | Feed-Thru            |                 |                 |                 |
|----------------------|-----------------|-----------------|-----------------|----------------------|-----------------|-----------------|-----------------|
| Strain Relief Covers |                 | Dust Covers     |                 | Strain Relief Covers |                 | Dust Covers     |                 |
| Cover Part Nos.      | No. of Circuits | Cover Part Nos. | No. of Circuits | Cover Part Nos.      | No. of Circuits | Cover Part Nos. | No. of Circuits |
| 643075               | 2-28            | 640550          | 2-28            | 643077               | 2-28            | 640642          | 3-28            |

**Cover Length**

| No. of Circuits | Dim. A        | Prefix/Suffix | No. of Circuits | Dim. A         | Prefix/Suffix | No. of Circuits | Dim. A         | Prefix/Suffix | No. of Circuits | Dim. A         | Prefix/Suffix |
|-----------------|---------------|---------------|-----------------|----------------|---------------|-----------------|----------------|---------------|-----------------|----------------|---------------|
| 2               | .200<br>5.08  | -2            | 9               | .900<br>22.86  | -9            | 16              | 1.600<br>40.64 | 1- -6         | 23              | 2.300<br>58.42 | 2- -3         |
| 3               | .300<br>7.62  | -3            | 10              | 1.00<br>25.4   | 1- -0         | 17              | 1.700<br>43.18 | 1- -7         | 24              | 2.400<br>60.96 | 2- -4         |
| 4               | .400<br>10.16 | -4            | 11              | 1.100<br>27.94 | 1- -1         | 18              | 1.800<br>45.72 | 1- -8         | 25              | 2.500<br>63.5  | 2- -5         |
| 5               | .500<br>12.7  | -5            | 12              | 1.200<br>30.48 | 1- -2         | 19              | 1.900<br>48.26 | 1- -9         | 26              | 2.600<br>66.04 | 2- -6         |
| 6               | .600<br>15.24 | -6            | 13              | 1.300<br>33.02 | 1- -3         | 20              | 2.000<br>50.8  | 2- -0         | 27              | 2.700<br>68.58 | 2- -7         |
| 7               | .700<br>17.78 | -7            | 14              | 1.400<br>35.56 | 1- -4         | 21              | 2.100<br>53.34 | 2- -1         | 28              | 2.800<br>71.12 | 2- -8         |
| 8               | .800<br>20.32 | -8            | 15              | 1.500<br>38.1  | 1- -5         | 22              | 2.200<br>55.88 | 2- -2         |                 |                |               |

MTA-100  
.100 [2.54]

**MTA-100 IDC Connector Accessories (Continued)**

**Keying Plug with Carrier Strip (10 plugs per strip)**  
**Part No. 641994-1**

**Material (RoHS Compliant)**  
UL94V-2 rated, nylon, natural color



**Note:** Removal of contact is not necessary when using keying plug.



**Replacement IDC Contacts**

**Material and Finish**

Phosphor bronze, post tin plated;  
.000030 [0.00076] or .000015 [0.00038] post gold plated over nickel

| Wire Size |                 | Part Numbers        |                               |                               |                |
|-----------|-----------------|---------------------|-------------------------------|-------------------------------|----------------|
| AWG       | mm <sup>2</sup> | Standard Tin Plated | .000030 [0.00076] Gold Plated | .000015 [0.00038] Gold Plated | LED Tin Plated |
| 22        | 0.3–0.4         | 640636-3            | 641186-4                      | 641186-3                      | 641643-2       |
| 24        | 0.2             | 640637-3            | 641187-4                      | 641187-3                      | 641644-2       |
| 26        | 0.12–0.15       | 640638-3            | 641188-4                      | 641188-3                      | 641645-2       |
| 28        | 0.08–0.09       | 640639-2            | 641189-4                      | 641189-3                      | 641646-2       |

**Note:** Tyco Electronics does not recommend terminating an MTA contact more than one time. Use replacement contacts when required for field repairs or wire changes.



**Crimp Snap-In Contacts**

**Material and Finish**

Phosphor bronze, tin plated



| Wire Size |                 | Part Nos.    |          |
|-----------|-----------------|--------------|----------|
| AWG       | mm <sup>2</sup> | Loose Piece* | Strip**  |
| 26-22     | 0.12–0.4        | 640709-2     | 640708-2 |

\*\*Hand Tool No. 59836-1 (IS 408-6527)  
\*\*Applicator No. 466747-1 (IS 408-8040)

- Special applications for crimp snap-in contacts are:
1. Double wire per contact
  2. Coax or shielded wire
  3. Mixed wire size in same connector

**Note:** Only one crimp snap-in contact per connector.

## MTA-100 Posted Connector/Connector Mateability Guide

This matrix has been prepared to assist you, our customer, in defining the correct mating halves for the MTA-100 posted connector and connector combination. Where a "Y" is indicated the combination is a valid mating pair. Where an "N" is indicated the combination is not acceptable for mating.

### Matrix for Tin Plated Part Numbers

### Posted Connectors

|         | 647000 | 647001 | 647002 | 647003 | 647004 | 647005 | 647006 | 647007 |
|---------|--------|--------|--------|--------|--------|--------|--------|--------|
| 640440  | Y      | Y      | Y      | Y      | Y      | Y      | Y      | Y      |
| 640441  | Y      | Y      | Y      | Y      | Y      | Y      | Y      | Y      |
| 640442  | Y      | Y      | Y      | Y      | Y      | Y      | Y      | Y      |
| 640443  | Y      | Y      | Y      | Y      | Y      | Y      | Y      | Y      |
| 640468  | Y      | Y      | Y      | Y      | Y      | Y      | Y      | Y      |
| 640469  | Y      | Y      | Y      | Y      | Y      | Y      | Y      | Y      |
| 640470  | Y      | Y      | Y      | Y      | Y      | Y      | Y      | Y      |
| 640471  | Y      | Y      | Y      | Y      | Y      | Y      | Y      | Y      |
| 640620  | Y      | Y      | Y      | Y      | Y      | Y      | Y      | Y      |
| 640621  | Y      | Y      | Y      | Y      | Y      | Y      | Y      | Y      |
| 640622  | Y      | Y      | Y      | Y      | Y      | Y      | Y      | Y      |
| 640623  | Y      | Y      | Y      | Y      | Y      | Y      | Y      | Y      |
| 641311  | Y      | Y      | Y      | Y      | Y      | Y      | Y      | Y      |
| 641312  | Y      | Y      | Y      | Y      | Y      | Y      | Y      | Y      |
| 641313  | Y      | Y      | Y      | Y      | Y      | Y      | Y      | Y      |
| 641314  | Y      | Y      | Y      | Y      | Y      | Y      | Y      | Y      |
| 641534  | Y      | Y      | Y      | Y      | Y      | Y      | Y      | Y      |
| 641535  | Y      | Y      | Y      | Y      | Y      | Y      | Y      | Y      |
| 641536  | Y      | Y      | Y      | Y      | Y      | Y      | Y      | Y      |
| 641537  | Y      | Y      | Y      | Y      | Y      | Y      | Y      | Y      |
| 641653  | Y      | Y      | Y      | Y      | Y      | Y      | Y      | Y      |
| 641654  | Y      | Y      | Y      | Y      | Y      | Y      | Y      | Y      |
| 641655  | Y      | Y      | Y      | Y      | Y      | Y      | Y      | Y      |
| 641656  | Y      | Y      | Y      | Y      | Y      | Y      | Y      | Y      |
| 643498  | Y      | Y      | Y      | Y      | Y      | Y      | Y      | Y      |
| 643813  | Y*     | Y*     | Y*     | Y*     | Y*     | Y*     | Y*     | Y*     |
| 643814  | Y*     | Y*     | Y*     | Y*     | Y*     | Y*     | Y*     | Y*     |
| 643815  | Y*     | Y*     | Y*     | Y*     | Y*     | Y*     | Y*     | Y*     |
| 643816  | Y*     | Y*     | Y*     | Y*     | Y*     | Y*     | Y*     | Y*     |
| 643828  | Y      | Y      | Y      | Y      | Y      | Y      | Y      | Y      |
| 644083  | Y*     | Y*     | Y*     | Y*     | Y*     | Y*     | Y*     | Y*     |
| 644312  | Y*     | Y*     | Y*     | Y*     | Y*     | Y*     | Y*     | Y*     |
| 644313  | Y*     | Y*     | Y*     | Y*     | Y*     | Y*     | Y*     | Y*     |
| 644497  | Y*     | Y*     | Y*     | Y*     | Y*     | Y*     | Y*     | Y*     |
| 644511  | Y*     | Y*     | Y*     | Y*     | Y*     | Y*     | Y*     | Y*     |
| 644512  | Y*     | Y*     | Y*     | Y*     | Y*     | Y*     | Y*     | Y*     |
| 644513  | Y*     | Y*     | Y*     | Y*     | Y*     | Y*     | Y*     | Y*     |
| 644514  | Y*     | Y*     | Y*     | Y*     | Y*     | Y*     | Y*     | Y*     |
| 644540  | Y*     | Y*     | Y*     | Y*     | Y*     | Y*     | Y*     | Y*     |
| 644563  | Y*     | Y*     | Y*     | Y*     | Y*     | Y*     | Y*     | Y*     |
| 644564  | Y*     | Y*     | Y*     | Y*     | Y*     | Y*     | Y*     | Y*     |
| 644565  | Y*     | Y*     | Y*     | Y*     | Y*     | Y*     | Y*     | Y*     |
| 644574  | Y      | Y      | Y      | Y      | Y      | Y      | Y      | Y      |
| 644575  | Y      | Y      | Y      | Y      | Y      | Y      | Y      | Y      |
| 644576  | Y      | Y      | Y      | Y      | Y      | Y      | Y      | Y      |
| 644577  | Y      | Y      | Y      | Y      | Y      | Y      | Y      | Y      |
| 644578  | Y*     | Y*     | Y*     | Y*     | Y*     | Y*     | Y*     | Y*     |
| 644579  | Y*     | Y*     | Y*     | Y*     | Y*     | Y*     | Y*     | Y*     |
| 644795  | Y*     | Y*     | Y*     | Y*     | Y*     | Y*     | Y*     | Y*     |
| 1375820 | N      | N      | N      | N      | N      | N      | N      | N      |

\*2 & 3 position MTA-100 Posted Connectors can not mate with MTA-100 connectors with polarizing tabs.

MTA-100  
.100 [2.54]

Connectors



### MTA-100 Posted Connector/Connector Mateability Guide (Continued)

This matrix has been prepared to assist you, our customer, in defining the correct mating halves for the MTA-100 posted connector and connector combination. Where a "Y" is indicated the combination is a valid mating pair. Where an "N" is indicated the combination is not acceptable for mating.

**Matrix for .000030  
[0.00076] Gold Plated  
Part Numbers**

|            |         | Posted Connectors |        |        |        |        |        |        |        |
|------------|---------|-------------------|--------|--------|--------|--------|--------|--------|--------|
|            |         | 647008            | 647009 | 647010 | 647011 | 647012 | 647013 | 647014 | 647015 |
| Connectors | 641237  | Y                 | Y      | Y      | Y      | Y      | Y      | Y      | Y      |
|            | 641238  | Y                 | Y      | Y      | Y      | Y      | Y      | Y      | Y      |
|            | 641239  | Y                 | Y      | Y      | Y      | Y      | Y      | Y      | Y      |
|            | 641240  | Y                 | Y      | Y      | Y      | Y      | Y      | Y      | Y      |
|            | 641241  | Y                 | Y      | Y      | Y      | Y      | Y      | Y      | Y      |
|            | 641242  | Y                 | Y      | Y      | Y      | Y      | Y      | Y      | Y      |
|            | 641243  | Y                 | Y      | Y      | Y      | Y      | Y      | Y      | Y      |
|            | 641244  | Y                 | Y      | Y      | Y      | Y      | Y      | Y      | Y      |
|            | 644020  | Y*                | Y*     | Y*     | Y*     | Y*     | Y*     | Y*     | Y*     |
|            | 644042  | Y*                | Y*     | Y*     | Y*     | Y*     | Y*     | Y*     | Y*     |
|            | 644043  | Y*                | Y*     | Y*     | Y*     | Y*     | Y*     | Y*     | Y*     |
|            | 644044  | Y*                | Y*     | Y*     | Y*     | Y*     | Y*     | Y*     | Y*     |
|            | 644702  | Y*                | Y*     | Y*     | Y*     | Y*     | Y*     | Y*     | Y*     |
|            | 644726  | Y*                | Y*     | Y*     | Y*     | Y*     | Y*     | Y*     | Y*     |
|            | 1375820 | N                 | N      | N      | N      | N      | N      | N      | N      |

\*2 & 3 position MTA-100 Posted Connectors can not mate with MTA-100 connectors with polarizing tabs.

**Matrix for .000015  
[0.00038] Gold Plated  
Part Numbers**

|            |         | Posted Connectors |        |        |        |        |        |        |        |
|------------|---------|-------------------|--------|--------|--------|--------|--------|--------|--------|
|            |         | 647008            | 647009 | 647010 | 647011 | 647012 | 647013 | 647014 | 647015 |
| Connectors | 641190  | Y                 | Y      | Y      | Y      | Y      | Y      | Y      | Y      |
|            | 641191  | Y                 | Y      | Y      | Y      | Y      | Y      | Y      | Y      |
|            | 641192  | Y                 | Y      | Y      | Y      | Y      | Y      | Y      | Y      |
|            | 641193  | Y                 | Y      | Y      | Y      | Y      | Y      | Y      | Y      |
|            | 641198  | Y                 | Y      | Y      | Y      | Y      | Y      | Y      | Y      |
|            | 641199  | Y                 | Y      | Y      | Y      | Y      | Y      | Y      | Y      |
|            | 641200  | Y                 | Y      | Y      | Y      | Y      | Y      | Y      | Y      |
|            | 641201  | Y                 | Y      | Y      | Y      | Y      | Y      | Y      | Y      |
|            | 644038  | Y*                | Y*     | Y*     | Y*     | Y*     | Y*     | Y*     | Y*     |
|            | 644040  | Y*                | Y*     | Y*     | Y*     | Y*     | Y*     | Y*     | Y*     |
|            | 647477  | Y*                | Y*     | Y*     | Y*     | Y*     | Y*     | Y*     | Y*     |
|            | 647480  | Y*                | Y*     | Y*     | Y*     | Y*     | Y*     | Y*     | Y*     |
|            | 1375820 | N                 | N      | N      | N      | N      | N      | N      | N      |
|            | 1744020 | Y*                | Y*     | Y*     | Y*     | Y*     | Y*     | Y*     | Y*     |

\*2 & 3 position MTA-100 Posted Connectors can not mate with MTA-100 connectors with polarizing tabs.

**MTA-100 IDC Posted Connectors (Wire-to-Wire)—Closed End, Feed-Thru**

**Material and Finish**

**Housing** — UL 94V-2 rated, nylon, see chart for color

**Contacts** — Copper alloy, post tin or gold plated over nickel (see chart)

**Notes:**

1. Mating half visuals - pages 14 & 15.
2. Use feed thru strain relief covers & feed thru dust covers (if needed) - page 16.
3. Approved wire listing - pages 70 thru 74.

MTA-100  
.100 [2.54]

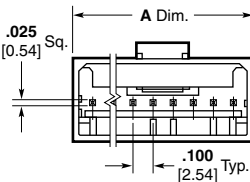

**Closed End**



**Feed-Thru**



**Connector Ordering Information**

The "Base Part Numbers" Chart at right shows the base part number.

Prefixes and suffixes are determined by the number of circuit positions in the connector. For example, the complete part number for a 12-position closed end connector for 22 AWG wire would be:

Base number **647000** plus prefix-and-suffix **4-2**

The correct ordering number is **4-647000-2**

All part numbers are the RoHS equivalent version. Example:

| No. of Pos. | Lead Free RoHS Prefix/Suffix |
|-------------|------------------------------|
| 2           | 3-647000-2                   |
|             | thru                         |
| 19          | 4-647000-9                   |

See page 15 for an explanation of RoHS lead free equivalents.

**Note:** All RoHS equivalent part numbers may not be available upon catalog release. If the number you need is not available, please contact Product Engineering to expedite your request.

**Color Coding by Wire Size for UL 94V-2 Connectors**

- 22 AWG — Red
- 24 AWG — White
- 26 AWG — Blue
- 28 AWG — Green

**Performance Data**

**Voltage Rating** — 250 VAC

**Current Rating** — 4 amp max.

**Low-Level Resistance** — 16 mΩ max. initial

**Dielectric Withstanding Voltage** — 750 VAC/1 min.

**Insulation Resistance** — 5000 MΩ min. initial

**Operating Temperature** —

**Base Part Numbers**

| Connector Type & Wire Size                              | Closed End Connector |                    | Feed-Thru Connector |                 |
|---|----------------------|--------------------|---------------------|-----------------|
|   | Part Nos.            | RoHS Equiv.        | Part Nos.           | No. of Circuits |
| <b>Standard UL 94V-2, Tin Plated</b>                    |                      |                    |                     |                 |
| 22 AWG<br>0.3–0.4 mm <sup>2</sup>                       | 647000               | 32–49 <sup>1</sup> | 647004              | — <sup>2</sup>  |
| 24 AWG<br>0.2 mm <sup>2</sup>                           | 647001               | 32–49 <sup>1</sup> | 647005              | — <sup>2</sup>  |
| 26 AWG<br>0.12–0.15 mm <sup>2</sup>                     | 647002               | 32–49 <sup>1</sup> | 647006              | — <sup>2</sup>  |
| 28 AWG<br>0.08–0.09 mm <sup>2</sup>                     | 647003               | 32–49 <sup>1</sup> | 647007              | — <sup>2</sup>  |
| <b>Standard UL 94V-2, .000030 [0.00076] Gold Plated</b> |                      |                    |                     |                 |
| 22 AWG<br>0.3–0.4 mm <sup>2</sup>                       | 647008               | 32–49 <sup>1</sup> | 647012              | — <sup>2</sup>  |
| 24 AWG<br>0.2 mm <sup>2</sup>                           | 647009               | 32–49 <sup>1</sup> | 647013              | — <sup>2</sup>  |
| 26 AWG<br>0.12–0.15 mm <sup>2</sup>                     | 647010               | 32–49 <sup>1</sup> | 647014              | — <sup>2</sup>  |
| 28 AWG<br>0.08–0.09 mm <sup>2</sup>                     | 647011               | 32–49 <sup>1</sup> | 647015              | — <sup>2</sup>  |
| <b>Standard UL 94V-2, .000015 [0.00038] Gold Plated</b> |                      |                    |                     |                 |
| 22 AWG<br>0.3–0.4 mm <sup>2</sup>                       | 647016               | 32–49 <sup>1</sup> | 647020              | — <sup>2</sup>  |
| 24 AWG<br>0.2 mm <sup>2</sup>                           | 647017               | 32–49 <sup>1</sup> | 647021              | — <sup>2</sup>  |
| 26 AWG<br>0.12–0.15 mm <sup>2</sup>                     | 647018               | 32–49 <sup>1</sup> | 647022              | — <sup>2</sup>  |
| 28 AWG<br>0.08–0.09 mm <sup>2</sup>                     | 647019               | 32–49 <sup>1</sup> | 647023              | — <sup>2</sup>  |

<sup>1</sup> 2 and 3 position MTA-100 Posted Connectors (Closed End) can not mate with MTA-100 connectors with polarizing tabs.  
<sup>2</sup> Parts may be manufactured upon request. Minimums may apply. Contact product engineer or product manager for details.

| No. of Circuits | Dim.         |              | No. of Circuits | Dim.          |              | No. of Circuits | Dim.          |               | No. of Circuits | Dim.          |               |
|-----------------|--------------|--------------|-----------------|---------------|--------------|-----------------|---------------|---------------|-----------------|---------------|---------------|
|                 | A            | B            |                 | A             | B            |                 | A             | B             |                 | A             | B             |
| 2               | .300 [7.62]  | .227 [5.77]  | 6               | .700 [17.78]  | .627 [15.93] | 10              | 1.100 [27.94] | 1.027 [26.09] | 14              | 1.500 [38.10] | 1.427 [36.25] |
| 3               | .400 [10.16] | .327 [8.31]  | 7               | .800 [20.32]  | .727 [18.47] | 11              | 1.200 [30.48] | 1.127 [28.63] | 15              | 1.600 [40.64] | 1.527 [38.79] |
| 4               | .500 [12.70] | .427 [10.85] | 8               | .900 [22.86]  | .827 [21.01] | 12              | 1.300 [33.02] | 1.227 [31.17] | 16              | 1.700 [43.18] | 1.627 [41.33] |
| 5               | .600 [15.24] | .527 [13.39] | 9               | 1.000 [25.40] | .927 [23.55] | 13              | 1.400 [35.56] | 1.327 [33.71] | 17              | 1.800 [45.72] | 1.727 [43.87] |
|                 |              |              |                 |               |              |                 |               |               | 18              | 1.900 [48.26] | 1.827 [46.41] |
|                 |              |              |                 |               |              |                 |               |               | 19              | 2.000 [50.80] | 1.927 [48.95] |

–55°C to +105°C

**Technical Documents**

**Product Specification**  
108-1050-1 MTA-100 Posted Connector

**Application Specification**  
114-1019 MTA-100 Connectors

**Replacement IDC Contacts**

**Material and Finish**

**Contacts** — Copper alloy, post tin or gold plated over nickel



| Wire Size<br>AWG mm <sup>2</sup> | Part Numbers |                               |
|----------------------------------|--------------|-------------------------------|
|                                  | Tin Plated   | .000030 [0.00076] Gold Plated |
| 22 0.3–0.4                       | 3-647030-1   | 3-647030-2                    |
| 24 0.2                           | 3-647031-1   | 3-647031-2                    |
| 26 0.12–0.15                     | 3-647032-1   | 3-647032-2                    |
| 28 0.8–0.9                       | 3-647033-1   | 3-647033-2                    |

## MTA-100 Flat Headers—Straight and Right-Angle

### Material and Finish

**Housing**—UL94V-0 rated, polyester, white

**Posts**—Copper alloy, tin plated, .000030 [0.00076] or .000015 [0.00038] gold over nickel

**Notes:**

1. Post(s) can be omitted for keying purposes. Specify the desired post(s) to be omitted using the figure to identify Post No. 1.
2. Gold headers are duplex plated, gold on mating end of post and tin on the solder tail.
3. To determine header overall length (dim. A) multiply .100 x the number of posts. Example: .100 x 10 posts equals 1.000 inch [25.4 mm].

For mateability options, see matrix on pages 12 and 13.

For mating half visuals, see pages 14, 15 and 31.

### Header Ordering Information

The “Base Part Numbers” Chart at right shows the base part number.

Prefixes and suffixes are determined by the number of post positions in the header. For example, the complete part number for a 10-position header with straight posts would be:

Base number **641211** plus prefix-and-suffix **4- — 0**

The correct ordering number is **4-641211-0**

All part numbers are the RoHS equivalent version. Example:

| No. of Pos. | Lead Free RoHS Prefix/Suffix |
|-------------|------------------------------|
| 2           | 3-641211-2                   |
|             | thru                         |
| 28          | 5-641211-8                   |

See page 15 for an explanation of RoHS lead free equivalents.

**Note:** All RoHS equivalent part numbers may not be available upon catalog release. If the number you need is not available, please contact Product Engineering to expedite your request.

**Note:** Select load headers (omitted pin headers) are available upon request. Please contact product engineer or product manager for details.

### Straight Post (.025 [0.64] Square)



### Right-Angle Post (.025 [0.64] Square)



X = .120 [3.05] min., .240 [6.1] max.  
when mated with MTA-100 Connector.  
X = .120 [3.05] min., when mated with  
CST-100 II Connector.



Recommended Mounting Hole Pattern for  
.062 [1.57] Thk. PC Board



Recommended Mounting Hole Pattern for  
.062 [1.57] Thk. PC Board

**Note:** Consult Product Drawing for details on placing headers onto PC boards.

### Base Part Numbers

| Straight Posts   |                          | Right-Angle Posts |                          |
|--|--------------------------|-------------------|--------------------------|
| Header Part Nos.                                       | No. of Posts/RoHS Equiv. | Header Part Nos.  | No. of Posts/RoHS Equiv. |
| <b>Standard UL94V-0, Tin Plated</b>                    |                          |                   |                          |
| 640452   | 2-28                     | 640453            | 2-28                     |
| <b>Standard UL94V-0, .000030 [0.00076] Gold Plated</b> |                          |                   |                          |
| 641211   | 2-28<br>32-58            | 641212            | 2-28<br>32-58            |
| <b>Standard UL94V-0, .000015 [0.00038] Gold Plated</b> |                          |                   |                          |
| 641122   | 2-28<br>32-58            | 641123            | 2-28<br>32-58            |

## MTA-100 Narrow Flat Headers—Straight and Right-Angle

### Material and Finish

**Housing** — UL94V-0 rated, polyester, white

**Posts** — Copper alloy, tin plated, .000030 [0.00076] or .000015 [0.00038] gold over nickel

**Notes:**

1. Post(s) can be omitted for keying purposes. Specify the desired post(s) to be omitted using the figure to identify Post No. 1.
2. Headers without retentive legs are suitable for breakaway application.
3. 2 or 3 retentive leg(s) per header, depending upon number of positions.
4. Gold headers are duplex plated, gold on mating end of post and tin on the solder tail.
5. To determine header overall length (dim. A) multiply .100 x the number of posts minus (-) .012. Example: .100 x 10 posts - .012 = .988 inches [25.1 mm].

For mateability options, see matrix on pages 12 and 13.

For mating half visuals, see pages 14, 15 and 31.

### Connector Ordering Information

The “Base Part Numbers” Chart at right shows the base part number.

Prefixes and suffixes are determined by the number of post positions in the header. For example, the complete part number for a 10-position header with straight posts and without retentive legs would be:

Base number **644456** plus prefix-and-suffix **4- -0**

The correct ordering number is **4-644456-0**

All part numbers are the RoHS equivalent version. Example:

| No. of Pos. | Lead Free RoHS Prefix/Suffix |
|-------------|------------------------------|
| 2           | 3-644456-2                   |
| thru        |                              |
| 28          | 5-644456-8                   |

See page 15 for an explanation of RoHS lead free equivalents.

**Note:** All RoHS equivalent part numbers may not be available upon catalog release. If the number you need is not available, please contact Product Engineering to expedite your request.

**Note:**

Select load headers (omitted pin headers) are available upon request. Please contact product engineer or product manager for details.

### Straight Post (.025 [0.64] Square)



### Right-Angle Post (.025 [0.64] Square)

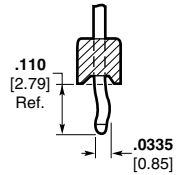
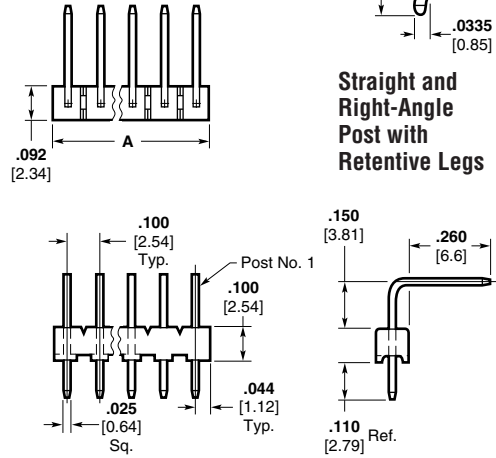

### Straight and Right-Angle Post with Retentive Legs



Recommended Mounting Hole Pattern for .062 [1.57] Thk. PC Board



Recommended Mounting Hole Pattern for .062 [1.57] Thk. PC Board

**Note:** Consult Product Drawing for details on placing headers onto PC boards.

### Base Part Numbers

| Straight Posts   |             |                     |             | Right-Angle Posts      |             |                     |             |
|--|-------------|---------------------|-------------|------------------------|-------------|---------------------|-------------|
| Without Retentive Legs                                 |             | With Retentive Legs |             | Without Retentive Legs |             | With Retentive Legs |             |
| Header Part Nos.                                       | RoHS Equiv. | Header Part Nos.    | RoHS Equiv. | Header Part Nos.       | RoHS Equiv. | Header Part Nos.    | RoHS Equiv. |
| <b>Standard UL94V-0, Tin Plated</b>                    |             |                     |             |                        |             |                     |             |
| 644456   | 32-58       | 644695              | 32-58       | 644457                 | 32-58       | 644694              | 32-58       |
| <b>Standard UL94V-0, .000030 [0.00076] Gold Plated</b> |             |                     |             |                        |             |                     |             |
| 644884   | 2-28        | 644886              | 2-28        | 644885                 | 2-28        | 644887              | 2-28        |
| <b>Standard UL94V-0, .000015 [0.00038] Gold Plated</b> |             |                     |             |                        |             |                     |             |
| 644888   | 2-28        | 644890              | 2-28        | 644889                 | 2-28        | 644891              | 2-28        |

High temperature product available. Please contact Sales Engineer or Product Information Center.

MTA-100 .100 [2.54]

**MTA-100 Polarized Headers—Straight and Right-Angle**

**Material and Finish**

**Housing** — UL94V-0 rated, polyester, white

**Posts** — Copper alloy, tin plated, .000030 [0.00076] or .000015 [0.00038] gold over nickel

**Notes:**

1. Post(s) can be omitted for keying purposes. Specify the desired post(s) to be omitted using the figure to identify Post No. 1.
2. Gold headers are duplex plated, gold on mating end of post and tin on the solder tail.
3. All posts on retentive leg headers are bent.
4. To determine header overall length (dim. A) multiply .100 x the number of posts. Example: .100 x 10 posts equals 1.000 inch [25.4 mm].

For mateability options, see matrix on pages 12 and 13.  
For mating half visuals, see pages 14, 15 and 31.

**Header Ordering Information**

The “Base Part Numbers” Chart at right shows the base part number.

Prefixes and suffixes are determined by the number of post positions in the header. For example, the complete part number for a 10-position header with straight posts would be:

Base number **641213** plus prefix-and-suffix **4- -0**

The correct ordering number is **4-641213-0**

All part numbers are the RoHS equivalent version. Example:

| No. of Pos. | Lead Free RoHS Prefix/Suffix |
|-------------|------------------------------|
| 2           | 3-641213-2                   |
|             | thru                         |
| 28          | 5-641213-8                   |

See page 15 for an explanation of RoHS lead free equivalents.

**Note:** All RoHS equivalent part numbers may not be available upon catalog release. If the number you need is not available, please contact Product Engineering to expedite your request.

**Note:** Select load headers (omitted pin headers) are available upon request. Please contact product engineer or product manager for details.

**Straight Post (.025 [0.64] Square)**



**Right-Angle Post (.025 [0.64] Square)**

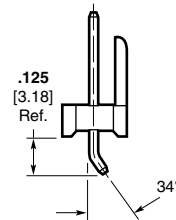
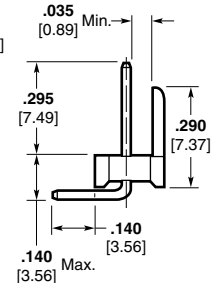
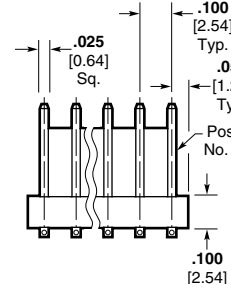
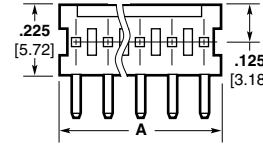

Retentive Leg

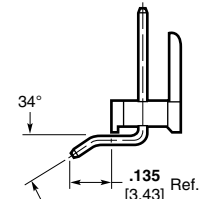

Retentive Leg



Recommended Mounting Hole Pattern for .062 [1.57] Thk. PC Board

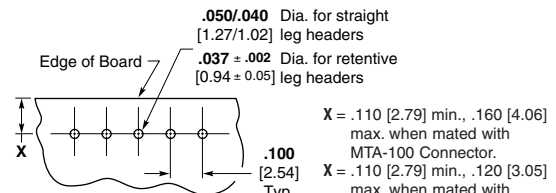

Recommended Mounting Hole Pattern for .062 [1.57] Thk. PC Board

**Note:** Consult Product Drawing for details on placing headers onto PC boards.

**Base Part Numbers**

| Straight Posts   |             |                     |             | Right-Angle Posts      |             |                     |             |
|--|-------------|---------------------|-------------|------------------------|-------------|---------------------|-------------|
| Without Retentive Legs                                 |             | With Retentive Legs |             | Without Retentive Legs |             | With Retentive Legs |             |
| Header Part Nos.                                       | RoHS Equiv. | Header Part Nos.    | RoHS Equiv. | Header Part Nos.       | RoHS Equiv. | Header Part Nos.    | RoHS Equiv. |
| <b>Standard UL94V-0, Tin Plated</b>                    |             |                     |             |                        |             |                     |             |
| 640454   | 2-28        | 644876              | 2-28        | 640455                 | 2-28        | 644877              | 2-28        |
| <b>Standard UL94V-0, .000030 [0.00076] Gold Plated</b> |             |                     |             |                        |             |                     |             |
| 641213   | 32-58       | —                   | —           | 641214                 | 32-58       | —                   | —           |
| <b>Standard UL94V-0, .000015 [0.00038] Gold Plated</b> |             |                     |             |                        |             |                     |             |
| 641124   | 32-58       | —                   | —           | 641125                 | 32-58       | —                   | —           |



**MTA-100 Friction Lock Headers—Straight and Right-Angle**

**Material and Finish**

**Housing**—UL94V-0 rated, polyester, white

**Posts**—Copper alloy, tin plated, .000030 [0.00076] or .000015 [0.00038] gold over nickel

**Notes:**

1. Post(s) can be omitted for keying purposes. Specify the desired post(s) to be omitted using the figure to identify Post No. 1.
2. Gold headers are duplex plated, gold on mating end of post and tin on the solder tail.
3. All posts on retentive leg headers are bent.
4. To determine header overall length (dim. A) multiply .100 x the number of posts. Example: .100 x 10 posts equals 1.000 inch [25.4 mm].

For mateability options, see matrix on pages 12 and 13.

For mating half visuals, see pages 14, 15 and 31.

**Header Ordering Information**

The “Base Part Numbers” Chart at right shows the base part number.

Prefixes and suffixes are determined by the number of post positions in the header. For example, the complete part number for a 10-position header with straight posts would be:

Base number **641215** plus prefix-and-suffix **4- -0**

The correct ordering number is **4-641215-0**

All part numbers are the RoHS equivalent version. Example:

| No. of Pos. | Standard Prefix/Suffix | Lead Free RoHS Prefix/Suffix |
|-------------|------------------------|------------------------------|
| 2           | 641215-2               | 3-641215-2                   |
| thru        |                        |                              |
| 28          | 2-641215-8             | 5-641215-8                   |

See page 15 for an explanation of RoHS lead free equivalents.

**Note:** All RoHS equivalent part numbers may not be available upon catalog release. If the number you need is not available, please contact Product Engineering to expedite your request.

**Note:** Select load headers (omitted pin headers) are available upon request. Please contact product engineer or product manager for details.

**Straight Post (.025 [0.64] Square)**



**Right-Angle Post (.025 [0.64] Square)**



**Recommended Mounting Hole Pattern for .062 [1.57] Thk. PC Board**



**Recommended Mounting Hole Pattern for .062 [1.57] Thk. PC Board**

**Note:** Consult Product Drawing for details on placing headers onto PC boards.

**Base Part Numbers**

| Straight Posts   |             |                     |             | Right-Angle Posts      |             |                     |             |
|--|-------------|---------------------|-------------|------------------------|-------------|---------------------|-------------|
| Without Retentive Legs                                 |             | With Retentive Legs |             | Without Retentive Legs |             | With Retentive Legs |             |
| Header Part Nos.                                       | RoHS Equiv. | Header Part Nos.    | RoHS Equiv. | Header Part Nos.       | RoHS Equiv. | Header Part Nos.    | RoHS Equiv. |
| <b>Standard UL94V-0, Tin Plated</b>                    |             |                     |             |                        |             |                     |             |
| 640456   | 2-28        | 644874              | 2-28        | 640457                 | 2-28        | 644875              | 2-28        |
| <b>Standard UL94V-0, .000030 [0.00076] Gold Plated</b> |             |                     |             |                        |             |                     |             |
| 641215   | 32-58       | —                   | —           | 641216                 | 32-58       | —                   | —           |
| <b>Standard UL94V-0, .000015 [0.00038] Gold Plated</b> |             |                     |             |                        |             |                     |             |
| 641126   | 32-58       | —                   | —           | 641127                 | 32-58       | —                   | —           |

MTA-100 .100 [2.54]

## MTA-100 Headers with Retention Peg—Straight

### Material and Finish

**Housing**—UL94V-0 rated, thermo-plastic, black

**Posts**—Copper alloy, tin plated, .000030 [0.00076] or .000015 [0.00038] gold over nickel

### Notes:

1. Post(s) can be omitted for keying purposes. Specify the desired post(s) to be omitted using the figure to identify Post No. 1.
2. Gold headers are duplex plated, gold on mating end of post and tin on the solder tail.
3. To determine header overall length (dim. A) multiply .100 x the number of posts. Example: .100 x 10 posts equals 1.000 inch [25.4 mm].

For mateability options, see matrix on pages 12 and 13.

For mating half visuals, see pages 14, 15 and 31.

### Header Ordering Information

The “Base Part Numbers” Chart at right shows the base part number.

Prefixes and suffixes are determined by the number of post positions in the header. For example, the complete part number for a 10-position header with straight posts would be:

Base number **647609** plus prefix-and-suffix  
**4- -0**

The correct ordering number is **4-647609-0**

All part numbers are the RoHS equivalent version. Example:

| No. of Pos. | Standard Prefix/Suffix | Lead Free RoHS Prefix/Suffix |
|-------------|------------------------|------------------------------|
| 2           | 647609-2               | 3-647609-2                   |
| 3           | 647609-3               | 3-647609-3                   |
| 4           | 647609-4               | 3-647609-4                   |
| 5           | 647609-5               | 3-647609-5                   |
| 6           | 647609-6               | 3-647609-6                   |
| 7           | 647609-7               | 3-647609-7                   |
| 8           | 647609-8               | 3-647609-8                   |
| 9           | 647609-9               | 3-647609-9                   |
| 10          | 1-647609-0             | 4-647609-0                   |
| 11          | 1-647609-1             | 4-647609-1                   |
| 12          | 1-647609-2             | 4-647609-2                   |

**Note:** All RoHS equivalent part numbers may not be available upon catalog release. If the number you need is not available, please contact Product Engineering to expedite your request.

### Friction Lock



### Polarized

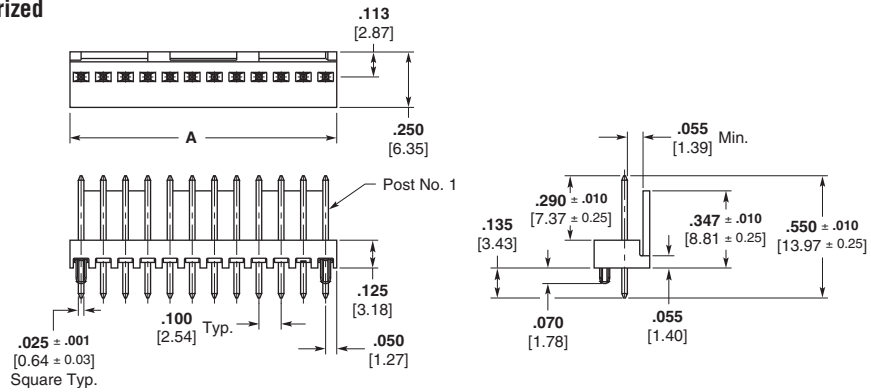

Recommended Mounting Hole Pattern for .062 [1.57] Thk. PC Board

**Note:** Consult Product Drawing for details on placing headers onto PC boards.

### Base Part Numbers

| Friction Lock  |             | Polarized        |             |
|--|-------------|------------------|-------------|
| Header Part Nos.                                       | RoHS Equiv. | Header Part Nos. | RoHS Equiv. |
| <b>Standard UL94V-0, Tin Plated</b>                    |             |                  |             |
| 647609   | 32-42       | 647623           | 32-42       |
| <b>Standard UL94V-0, .000030 [0.00076] Gold Plated</b> |             |                  |             |
| 647626   | 32-42       | 647624           | 32-42       |
| <b>Standard UL94V-0, .000015 [0.00038] Gold Plated</b> |             |                  |             |
| 647627   | 32-42       | 647625           | 32-42       |

### Note:

Select load headers (omitted pin headers) are available upon request. Please contact product engineer or product manager for details.

MTA-100  
.100 [2.54]

## MTA-100 High Profile Headers—Right-Angle

### Material and Finish

**Housing**—UL94V-0 rated, thermo-plastic, black

**Posts**—Copper alloy, tin plated, .000030 [0.00076] or .000015 [0.00038] gold over nickel

#### Notes:

1. Post(s) can be omitted for keying purposes. Specify the desired post(s) to be omitted using the figure to identify Post No. 1.
2. Gold headers are duplex plated, gold on mating end of post and tin on the solder tail.
3. To determine header overall length (dim. A) multiply .100 x the number of posts. Example: .100 x 10 posts equals 1.000 inch [25.4 mm].
4. This product can be mounted in the middle of the PC Board as shown in the PCB layout.

For mateability options, see matrix on pages 12 and 13.

For mating half visuals, see pages 14, 15 and 31.

### Header Ordering Information

The "Base Part Numbers" Chart at right shows the base part number.

Prefixes and suffixes are determined by the number of post positions in the header. For example, the complete part number for a 10-position header with right-angle posts would be:

Base number **647630** plus prefix-and-suffix  
**4- -0**

The correct ordering number is **4-647630-0**

All part numbers are the RoHS equivalent version. Example:

| No. of Pos. | Lead Free RoHS Prefix/Suffix |
|-------------|------------------------------|
| 2           | 3-647630-2                   |
| 3           | 3-647630-3                   |
| 4           | 3-647630-4                   |
| 5           | 3-647630-5                   |
| 6           | 3-647630-6                   |
| 7           | 3-647630-7                   |
| 8           | 3-647630-8                   |
| 9           | 3-647630-9                   |
| 10          | 4-647630-0                   |
| 11          | 4-647630-1                   |
| 12          | 4-647630-2                   |

**Note:** All RoHS equivalent part numbers may not be available upon catalog release. If the number you need is not available, please contact Product Engineering to expedite your request.

### Friction Lock

#### Right-Angle Post (.025 [0.64] Square)

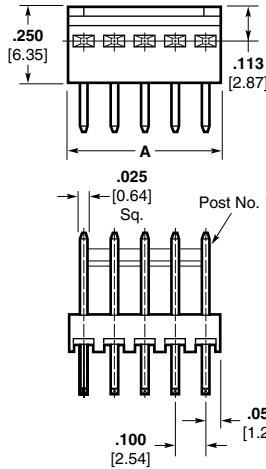

### Polarized

#### Right-Angle Post (.025 [0.64] Square)

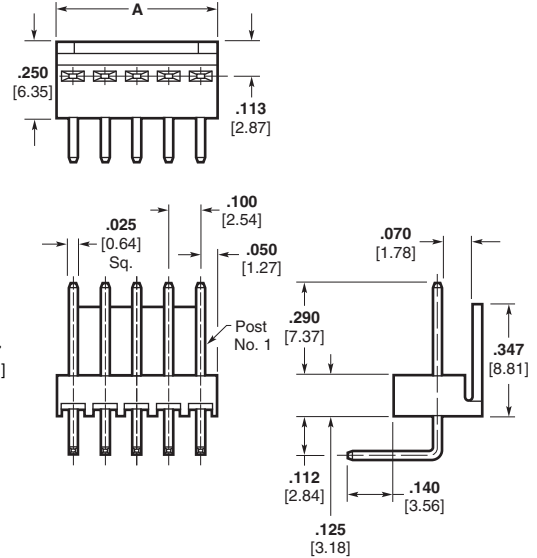

Recommended Mounting Hole Pattern for .062 [1.57] Thk. PC Board

**Note:** Consult Product Drawing for details on placing headers onto PC boards.

### Base Part Numbers

| Friction Lock  |             | Polarized         |             |
|--|-------------|-------------------|-------------|
| Right-Angle Posts                                      |             | Right-Angle Posts |             |
| Header Part Nos.                                       | RoHS Equiv. | Header Part Nos.  | RoHS Equiv. |
| <b>Standard UL94V-0, Tin Plated</b>                    |             |                   |             |
| 647630   | 32-42       | 647651            | 32-42       |
| <b>Standard UL94V-0, .000030 [0.00076] Gold Plated</b> |             |                   |             |
| 647629   | 32-42       | 647653            | 32-42       |
| <b>Standard UL94V-0, .000015 [0.00038] Gold Plated</b> |             |                   |             |
| 647628   | 32-42       | 647652            | 32-42       |

#### Note:

Select load headers (omitted pin headers) are available upon request. Please contact product engineer or product manager for details.

MTA-100  
.100 [2.54]

## MTA-100 Polarized High Temperature Headers—Straight and Right-Angle

### Material and Finish

#### Housing —

2–12 Position — UL94V-0 rated,  
nylon, black  
13–18 Position — UL94V-0 rated,  
LCP, black

**Posts**—Copper alloy, tin plated,  
.000030 [0.00076] or .000015  
[0.00038] gold over nickel

#### Notes:

1. Post(s) can be omitted for keying purposes. Specify the desired post(s) to be omitted using the figure to identify Post No. 1.
2. Gold headers are duplex plated, gold on mating end of post and tin on the solder tail.
3. To determine header overall length (dim. A) multiply .100 x the number of posts. Example: .100 x 10 posts equals 1.000 inch [25.4 mm].

For mateability options, see matrix on pages 12 and 13.

For mating half visuals, see pages 14, 15 and 31.

### Header Ordering Information

The “Base Part Numbers” Chart at right shows the base part number.

Prefixes and suffixes are determined by the number of post positions in the header. For example, the complete part number for a 10-position header with straight posts would be:

Base number **647047** plus  
prefix-and-suffix  
**4- -0**

The correct ordering number is  
**4-647047-0**

All part numbers are the RoHS equivalent version. Example:

| No. of Pos. | Lead Free RoHS Prefix/Suffix |
|-------------|------------------------------|
| 2           | 3-647047-2                   |
|             | thru                         |
| 12          | 4-647047-2                   |
| 13          | NA                           |
|             | thru                         |
| 18          | NA                           |

See page 15 for an explanation of RoHS lead free equivalents.

**Note:** All RoHS equivalent part numbers may not be available upon catalog release. If the number you need is not available, please contact Product Engineering to expedite your request.

### For use with Infrared Reflow Process

Maximum Temperature Rating: 2–12 Position: 280°C  
13–18 Position: 235°C

#### Straight Post (.025 [0.64] Square)



#### Right-Angle Post (.025 [0.64] Square)



**Note:** Consult Product Drawing for details on placing headers onto PC boards.

Recommended Mounting Hole Pattern for .062 [1.57] Thick PC Board

### Base Part Numbers

| Straight Posts   |             | Straight Posts (Tube Loaded) |             | Right-Angle Posts |             |
|--|-------------|------------------------------|-------------|-------------------|-------------|
| Header Part Nos.                                       | RoHS Equiv. | Header Part Nos.             | RoHS Equiv. | Header Part Nos.  | RoHS Equiv. |
| <b>Standard UL94V-0, Tin Plated</b>                    |             |                              |             |                   |             |
| 647047   | 32-42       | 647298                       | 32-42       | 647048            | 32-42       |
| <b>Standard UL94V-0, .000030 [0.00076] Gold Plated</b> |             |                              |             |                   |             |
| 647109   | 32-42       | 647300                       | 32-42       | 647114            | 32-42       |
| <b>Standard UL94V-0, .000015 [0.00038] Gold Plated</b> |             |                              |             |                   |             |
| 647075   | 32-42       | 647299                       | 32-42       | 647076            | 32-42       |

**Note:** Select load headers (omitted pin headers) are available upon request. Please contact product engineer or product manager for details.

**MTA-100 Friction Lock High Temperature Headers—Straight and Right-Angle**

**Material and Finish**

**Housing** —  
 2–12 Position — UL94V-0 rated, nylon, black  
 13–18 Position — UL94V-0 rated, LCP, black

**Posts** — Copper alloy, tin plated, .000030 [0.00076] or .000015 [0.00038] gold over nickel

**Notes:**

1. Post(s) can be omitted for keying purposes. Specify the desired post(s) to be omitted using the figure to identify Post No. 1.
2. Gold headers are duplex plated, gold on mating end of post and tin on the solder tail.
3. To determine header overall length (dim. A) multiply .100 x the number of posts. Example: .100 x 10 posts equals 1.000 inch [25.4 mm].

For mateability options, see matrix on pages 12 and 13.  
 For mating half visuals, see pages 14, 15 and 31.

**Header Ordering Information**

The “Base Part Numbers” Chart at right shows the base part number.  
 Prefixes and suffixes are determined by the number of post positions in the header. For example, the complete part number for a 10-position header with straight posts would be:  
 Base number **647050** plus prefix-and-suffix **4- -0**  
 The correct ordering number is **4-647050-0**

All part numbers are the RoHS equivalent version. Example:

| No. of Pos. | Standard Prefix/Suffix | Lead Free RoHS Prefix/Suffix |
|-------------|------------------------|------------------------------|
| 2           | 647050-2               | 3-647050-2                   |
| thru        |                        |                              |
| 12          | 1-647050-2             | 4-647050-2                   |
| 13          | 1-647050-3             | NA                           |
| thru        |                        |                              |
| 18          | 1-647050-8             | NA                           |

See page 15 for an explanation of RoHS lead free equivalents.

**Note:** All RoHS equivalent part numbers may not be available upon catalog release. If the number you need is not available, please contact Product Engineering to expedite your request.

**For use with Infrared Reflow Process**

**Maximum Temperature Rating:** 2–12 Position: 280°C  
 13–18 Position: 235°C

**Straight Post (.025 [0.64] Square)**

**Right-Angle Post (.025 [0.64] Square)**

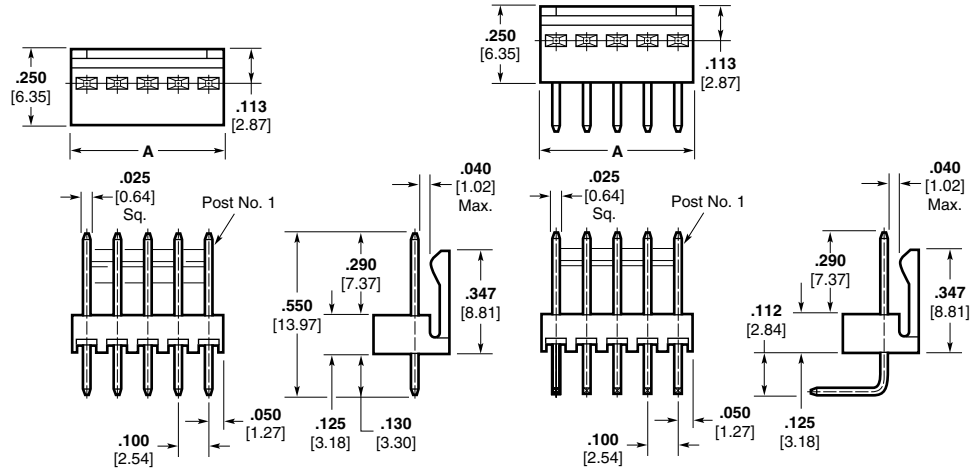

**Note:** Consult Product Drawing for details on placing headers onto PC boards.

**Recommended Mounting Hole Pattern for .062 [1.57] Thick PC Board**

**Base Part Numbers**

| Straight Posts   |             | Straight Posts (Tube Loaded) |             | Right-Angle Posts |             |
|--|-------------|------------------------------|-------------|-------------------|-------------|
| Header Part Nos.                                       | RoHS Equiv. | Header Part Nos.             | RoHS Equiv. | Header Part Nos.  | RoHS Equiv. |
| <b>Standard UL94V-0, Tin Plated</b>                    |             |                              |             |                   |             |
| 647050   | 32-42       | 647295                       | 32-42       | 647051            | 32-42       |
| <b>Standard UL94V-0, .000030 [0.00076] Gold Plated</b> |             |                              |             |                   |             |
| 647116   | 32-42       | 647297                       | 32-42       | 647117            | 32-42       |
| <b>Standard UL94V-0, .000015 [0.00038] Gold Plated</b> |             |                              |             |                   |             |
| 647078   | 32-42       | 647296                       | 32-42       | 647079            | 32-42       |

**Note:** Select load headers (omitted pin headers) are available upon request. Please contact product engineer or product manager for details.

MTA-100  
 .100 [2.54]



## MTA-100 Polarized and Friction Lock Surface Mount Headers—Straight

### Material and Finish

#### Housing —

2–12 Position — UL94V-0 rated, nylon, black  
13–18 Position — UL94V-0 rated, LCP, black

**Posts** — Copper alloy, tin plated, .000030 [0.00076] or .000015 [0.00038] gold over nickel

#### Notes:

1. Post(s) can be omitted for keying purposes. Specify the desired post(s) to be omitted using the figure to identify Post No. 1.
2. Gold headers are duplex plated, gold on mating end of post and tin on the solder tail.
3. To determine header overall length (dim. A) multiply .100 x the number of posts. Example: .100 x 10 posts equals 1.000 inch [25.4 mm].

For mateability options, see matrix on pages 12 and 13.

For mating half visuals, see pages 14, 15 and 31.

### Header Ordering Information

The “Base Part Numbers” Chart at right shows the base part number.

Prefixes and suffixes are determined by the number of post positions in the header. For example, the complete part number for a 10-position surface mount polarized header would be:

Base number **647106** plus prefix-and-suffix  
**4- -0**

The correct ordering number is **4-647106-0**

All part numbers are the RoHS equivalent version. Example:

| No. of Pos. | Lead Free RoHS Prefix/Suffix |
|-------------|------------------------------|
| 2           | 3-647106-2                   |
| 12          | 4-647106-2                   |

See page 15 for an explanation of RoHS lead free equivalents.

**Note:** All RoHS equivalent part numbers may not be available upon catalog release. If the number you need is not available, please contact Product Engineering to expedite your request.

### For use with Infrared Reflow Process

Maximum Temperature Rating: 2–12 Position: 280°C  
13–18 Position: 235°C

#### Polarized Header



#### Friction Lock Header



**Note:** Consult Product Drawing for details on placing headers onto PC boards.

Recommended PC Board Layout for use with .010 [0.25] Thick Stencil

### Base Part Numbers

| Polarized Headers                                      |             | Friction Lock Headers |             |
|--|-------------|-----------------------|-------------|
| Header Part Nos.                                       | RoHS Equiv. | Header Part Nos.      | RoHS Equiv. |
| <b>Standard UL94V-0, Tin Plated</b>                    |             |                       |             |
| 647106   | 32-42       | 647166                | 32-42       |
| <b>Standard UL94V-0, .000030 [0.00076] Gold Plated</b> |             |                       |             |
| 647108   | 32-42       | 647168                | 32-42       |
| <b>Standard UL94V-0, .000015 [0.00038] Gold Plated</b> |             |                       |             |
| 647107   | 32-42       | 647167                | 32-42       |

### Tape Mount Part Numbers

| Polarized Headers                                      |             | Friction Lock Headers |             |
|--|-------------|-----------------------|-------------|
| Header Part Nos.                                       | RoHS Equiv. | Header Part Nos.      | RoHS Equiv. |
| <b>Standard UL94V-0, Tin Plated</b>                    |             |                       |             |
| 647531   | 32-42       | 647502                | 32-42       |
| <b>Standard UL94V-0, .000030 [0.00076] Gold Plated</b> |             |                       |             |
|  |             | 1744163               | 32-42       |
| <b>Standard UL94V-0, .000015 [0.00038] Gold Plated</b> |             |                       |             |
|  |             | 647467                | 32-42       |

**Note:** Select load headers (omitted pin headers) are available upon request. Please contact product engineer or product manager for details.

MTA-100  
.100 [2.54]

## MTA-100 Shrouded Headers—Straight and Right-Angle

### Material and Finish

**Housing**—UL94V-0 rated, polyester, black

**Posts**—Copper alloy, tin plated; or .000030 [0.00076] gold over nickel

**Notes:**

1. Post(s) can be omitted for keying purposes. Specify the desired post(s) to be omitted using the figure to identify Post No. 1.
2. Headers with .000015 [0.00038] gold plated post are available upon request. Minimums may apply.
3. Gold headers are duplex plated, gold on mating end of post and tin on the solder tail.

For mateability options, see matrix on pages 12 and 13.

For mating half visuals, see pages 14 and 15.

### Header Ordering Information

The “Base Part Numbers” Chart at right shows the base part number.

Prefixes and suffixes are determined by the number of post positions in the header. For example, the complete part number for a 10-position header with straight posts and with pegs would be:

Base number **644486** plus prefix-and-suffix **4- -0**

The correct ordering number is **4-644486-0**

See page 15 for an explanation of RoHS lead free equivalents.

**Note:** All RoHS equivalent part numbers may not be available upon catalog release. If the number you need is not available, please contact Product Engineering to expedite your request.

**Notes:**

1. Select load headers (omitted pin headers) are available upon request. Please contact product engineer or product manager for details.
2. MTA-100 shrouded headers do not mate with CST-100 II housings.

### Header Length

| No. of Circuits | Dim. A        | Prefix/Suffix |
|-----------------|---------------|---------------|
| 2               | .284<br>7.21  | 3- -2         |
| 3               | .384<br>9.75  | 3- -3         |
| 4               | .484<br>12.29 | 3- -4         |
| 5               | .584<br>14.83 | 3- -5         |

### Straight Post (.025 [0.64] Square)



### Right-Angle (.025 [0.64] Square)

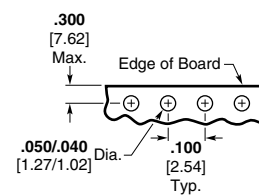
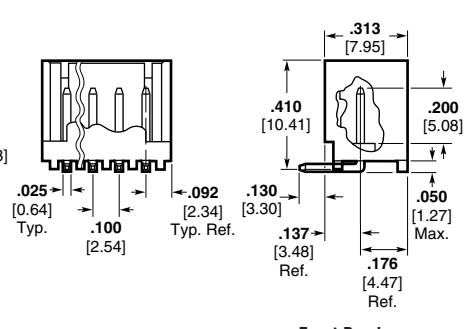
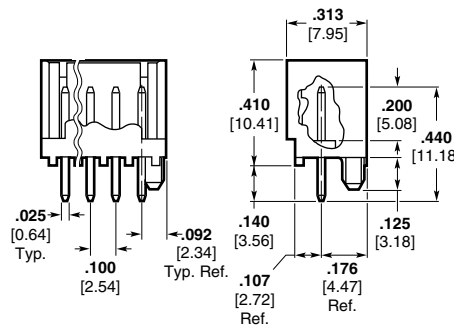

Front Bend

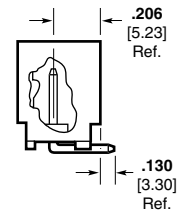

Rear Bend

**Note:** Consult Product Drawing for details on placing headers onto PC boards.

Recommended Mounting Hole Pattern for .062 [1.57] Thk. PC Board (Solder Side of Board Shown)

Recommended Mounting Hole Pattern for .062 [1.57] Thk. PC Board (Solder Side of Board Shown)

### Base Part Numbers

| Straight Posts   |             |                  |             | Right-Angle Posts |             |           |             |
|--|-------------|------------------|-------------|-------------------|-------------|-----------|-------------|
| With Pegs  |             | Without Pegs     |             | Without Pegs Only |             |           |             |
| Header Part Nos.                                       | RoHS Equiv. | Header Part Nos. | RoHS Equiv. | Front Bend        | RoHS Equiv. | Rear Bend | RoHS Equiv. |
| <b>Standard UL94V-0, Tin Plated</b>                    |             |                  |             |                   |             |           |             |
| 644486   | 22-34       | 644861           | 22-34       | 644488            | 22-34       | 644803    | 22-34       |
| <b>Standard UL94V-0, .000030 [0.00076] Gold Plated</b> |             |                  |             |                   |             |           |             |
| 644487   | 22-34       | —                | —           | 644489            | 22-34       | —         | —           |

### Header Length



| No. of Circuits | Dim. A        | Prefix/Suffix |
|-----------------|---------------|---------------|
| 6               | .684<br>17.37 | 3- -6         |
| 7               | .784<br>19.91 | 3- -7         |
| 8               | .884<br>22.45 | 3- -8         |
| 9               | .984<br>24.99 | 3- -9         |

| No. of Circuits | Dim. A         | Prefix/Suffix |
|-----------------|----------------|---------------|
| 10              | 1.084<br>27.53 | 4- -0         |
| 11              | 1.184<br>30.07 | 4- -1         |
| 12              | 1.284<br>32.61 | 4- -2         |
| 13              | 1.384<br>35.15 | 4- -3         |

| No. of Circuits | Dim. A         | Prefix/Suffix |
|-----------------|----------------|---------------|
| 14              | 1.484<br>37.69 | 4- -4         |

## .100 [2.54] Centerline CST-100 II Crimp Contacts and Housings

### Product Facts

- Low cost wire-to-board interconnections
- Wide wire range for single contact
- Tin and gold plated contacts
- Mates with specified MTA and similar competitive notched headers
- Plastic latching feature in housing helps prevent contact backout
- Locking ramps and polarizing tabs are standard
- For keying purposes use keying plug 641994-1 (page 17)
- Recognized under the Component Program of Underwriters Laboratories Inc., File No. E28476 
- Certified by Canadian Standards Association, File No. LR7189 

For mateability options, see matrix on pages 12 and 13.

For mating half visuals, see pages 21 thru 29 and 32.

See page 15 for an explanation of RoHS lead free equivalents.

### Performance Data

**Voltage Rating** — 250 vac

**Current Rating** — 4 amp max.

**Low-Level Resistance** — 6 mΩ max. initial; 10 mΩ max. final

**Insulation Resistance** — 1000 MΩ min. initial; 100 MΩ min. final

**Operating Temperature** — -55° C to +105° C

### Technical Documents

**Product Specification**  
108-1948

**Application Specification**  
114-13036

**Instruction Sheet**  
408-8493

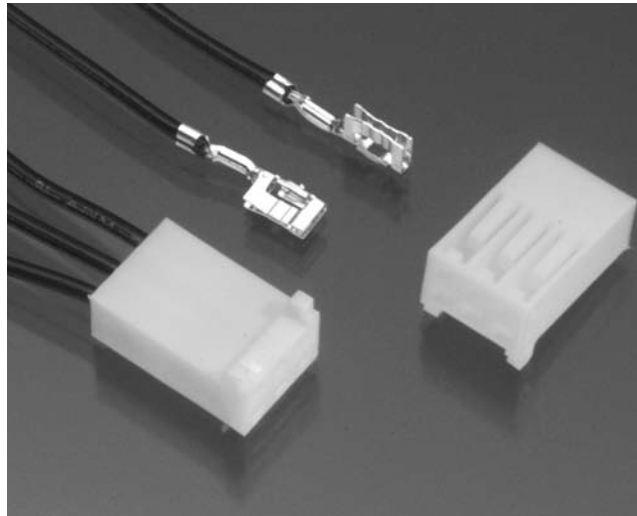

### Contacts

| Part Numbers            |                         |                         |
|-------------------------|-------------------------|-------------------------|
| Tin Plated              | 15 Au Gold Plated       | 30 Au Gold Plated       |
| 1375819-1 (Strip)       | 1375819-2 (Strip)       | 1375819-3 (Strip)       |
| 1445336-1 (Loose Piece) | 1445336-2 (Loose Piece) | 1445336-3 (Loose Piece) |

### Material and Finish (RoHS Compliant)

Phosphor bronze, pretinned or .000015 [.00038] gold, over nickel  
.000030 [0.00076] gold over nickel

**Wire Range** — 22–26 AWG [0.35–0.13 mm<sup>2</sup>]

**Max. Ins. Dia.** — .065 [1.65]

### Housing\*

#### Material (RoHS Compliant)

UL94V-0 rated, nylon, white

| No. of Pos. | Dim. A         | Part Numbers | No. of Pos. | Dim. A         | Part Numbers |
|-------------|----------------|--------------|-------------|----------------|--------------|
| 2           | .220<br>5.59   | 1375820-2    | 16          | 1.620<br>41.15 | 1-1375820-6  |
| 3           | .320<br>8.13   | 1375820-3    | 17          | 1.720<br>43.69 | 1-1375820-7  |
| 4           | .420<br>10.67  | 1375820-4    | 18          | 1.820<br>46.23 | 1-1375820-8  |
| 5           | .520<br>13.21  | 1375820-5    | 19          | 1.920<br>48.77 | 1-1375820-9  |
| 6           | .620<br>15.75  | 1375820-6    | 20          | 2.020<br>51.31 | 2-1375820-0  |
| 7           | .720<br>18.29  | 1375820-7    | 21          | 2.120<br>53.85 | 2-1375820-1  |
| 8           | .820<br>20.83  | 1375820-8    | 22          | 2.220<br>56.39 | 2-1375820-2  |
| 9           | .920<br>23.37  | 1375820-9    | 23          | 2.320<br>58.93 | 2-1375820-3  |
| 10          | 1.020<br>25.91 | 1-1375820-0  | 24          | 2.420<br>61.47 | 2-1375820-4  |
| 11          | 1.120<br>28.45 | 1-1375820-1  | 25          | 2.520<br>64.01 | 2-1375820-5  |
| 12          | 1.220<br>30.99 | 1-1375820-2  | 26          | 2.620<br>66.55 | 2-1375820-6  |
| 13          | 1.320<br>33.53 | 1-1375820-3  | 27          | 2.720<br>69.09 | 2-1375820-7  |
| 14          | 1.420<br>36.07 | 1-1375820-4  | 28          | 2.820<br>71.63 | 2-1375820-8  |
| 15          | 1.520<br>38.61 | 1-1375820-5  |             |                |              |

### Application Tooling

#### Loose Piece Contacts —

Hand Tool No. 58517-3 (408-4064)

#### Strip Contacts —

AMP-O-LECTRIC Model "G"

Termination Machine\*

Applicator No. 567373-3

(Request Catalog 65828)

AMP-O-MATIC Stripper-Crimper

Machine\* Applicator No. 567910-1 or

567827-1 (with QQM) (Request Catalog 65004)

AMPOMATOR CLS IIIG Lead Making

Machine\* (Request Catalog 82659)

\*Requires applicators. For part numbers, call Technical Support.

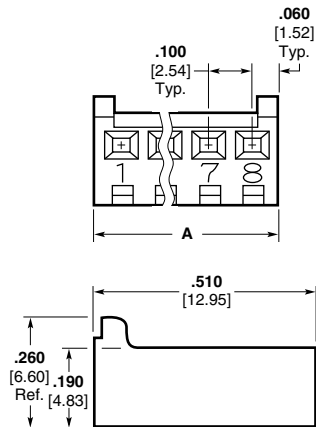
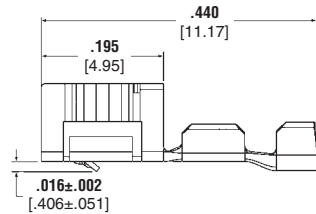

\*Housings without polarizing tabs may be manufactured upon request. Minimums may apply. Contact product engineering or product manager for details.

## CST-100 II Shrouded Headers—Straight and Right-Angle

### Material and Finish

**Housing**—UL94V-0 rated, polyester, black

**Posts**—Copper alloy, tin plated; or .000030 [0.00076] gold over nickel

**Notes:**

1. Post(s) can be omitted for keying purposes. Specify the desired post(s) to be omitted using the figure to identify Post No. 1.
2. Headers with .000015 [0.00038] gold plated posts are available upon request. Minimums may apply.
3. Gold headers are duplex plated, gold on mating end of post and tin on the solder tail.

For mateability options, see matrix on pages 12 and 13.

For mating half visuals, see page 31.

### Header Ordering Information

The “Base Part Numbers” Chart at right shows the base part number and number of posts available for the described headers.

Prefixes and suffixes are determined by the number of post positions in the header. For example, the complete part number for a 10-position header with straight posts and with pegs would be:

Base number **644893** plus prefix-and-suffix **4- -0**

The correct ordering number is **4-644893-0**

All part numbers are the RoHS equivalent version. Example:

| No. of Pos. | Lead Free RoHS Prefix/Suffix |
|-------------|------------------------------|
| 2           | 3-644893-2                   |
|             | thru                         |
| 14          | 4-644893-4                   |

See page 15 for an explanation of RoHS lead free equivalents.

**Note:** All RoHS equivalent part numbers may not be available upon catalog release. If the number you need is not available, please contact Product Engineering to expedite your request.

**Note:**

CST-100 II shrouded headers **only** mate with CST-100 II housings. All the MTA-100 headers except the MTA-100 shrouded headers mate with CST-100 II housings.

### Straight Post (.025 [0.64] Square)



Recommended Mounting Hole Pattern for .062 [1.57] Thk. PC Board (Solder Side of Board Shown)

### Right-Angle (.025 [0.64] Square)



Recommended Mounting Hole Pattern for .062 [1.57] Thk. PC Board (Solder Side of Board Shown)

**Note:** Consult Product Drawing for details on placing headers onto PC boards.

### Base Part Numbers

| Straight Posts   |                          |                  |                          | Right-Angle Posts Without Pegs Only |                          |
|--|--------------------------|------------------|--------------------------|-------------------------------------|--------------------------|
| With Pegs  |                          | Without Pegs     |                          | Header Part Nos.                    | No. of Posts/RoHS Equiv. |
| Header Part Nos.                                       | No. of Posts/RoHS Equiv. | Header Part Nos. | No. of Posts/RoHS Equiv. | Header Part Nos.                    | No. of Posts/RoHS Equiv. |
| <b>Standard UL94V-0, Tin Plated</b>                    |                          |                  |                          |                                     |                          |
| 644893   | 32-44                    | 644892           | 32-44                    | 644894                              | 32-44                    |
| <b>Standard UL94V-0, .000030 [0.00076] Gold Plated</b> |                          |                  |                          |                                     |                          |
| 644897   | 32-44                    | 644896           | 32-44                    | 644898                              | 32-44                    |

### Header Length

| No. of Circuits | Dim. A        | Prefix/Suffix | No. of Circuits | Dim. A        | Prefix/Suffix | No. of Circuits | Dim. A         | Prefix/Suffix |
|-----------------|---------------|---------------|-----------------|---------------|---------------|-----------------|----------------|---------------|
| 2               | .284<br>7.21  | 3- -2         | 5               | .584<br>14.83 | 3- -5         | 8               | .884<br>22.45  | 3- -8         |
| 3               | .384<br>9.75  | 3- -3         | 6               | .684<br>17.37 | 3- -6         | 9               | .984<br>24.99  | 3- -9         |
| 4               | .484<br>12.29 | 3- -4         | 7               | .784<br>19.91 | 3- -7         | 10              | 1.084<br>27.53 | 4- -0         |

CST-100 II  
.100 [2.54]



## .156 [3.96] Centerline MTA-156 IDC Connectors and Headers

### Product Facts

- Connectors and headers for 2 through 24 positions; wire sizes of 18, 20, 22, 24 and 26 AWG [0.9–0.12 mm<sup>2</sup>]
- Connectors and headers, except shrouded headers, are end-to-end stackable
- Quad Connectors for higher current rating (page 54)
- Posted connectors for 2, 3, 4, 6, 9, 12, 15 and 24 positions
- Card edge connectors for 3, 6, 9, 12, 15, 18 and 20 through 24 positions
- Connectors preloaded with IDC contacts
- All contacts are slotted for insulation displacement (IDC) termination technique
- Connector styles include both closed end and feed-thru, with and without locking ramps and polarizing tabs
- Molded ribs on housing do not allow reverse mating
- Contacts are lubricated for fretting corrosion protection
- Benefits derived from the MTA-156 system include increases quality and ease of handling such as —
  - One-step assembly
  - No wire stripping
  - No contact damage
  - Reduced wiring errors
  - Simpler tooling
  - Simple maintenance and repair
- Meets the material requirements of Table 23.1 of UL 1410 Standards for Television Receiver and Video Products (wire-to-post connectors only)
- Recognized under the Component Program of Underwriters Laboratories Inc.,  File No. E28476
- Certified by Canadian Standards Association,  File No. LR7189



MTA-156 connectors accept discrete and ribbon cable wire sizes ranging from 18–26 AWG [0.9–0.12 mm<sup>2</sup>] with maximum insulation outside diameter .095 [2.41] for single wire and .070 [1.78] for mass termination of wires. Tin plated solid, fused stranded or stranded (7, 16, and 19 strands) wire with PVC insulation can be used on 18 AWG [0.8–0.9 mm<sup>2</sup>] MTA-156 connectors; 7, 10, and 19 stranded wire on 20 AWG [0.5–0.6 mm<sup>2</sup>] MTA-156 connectors; and 7 and 19 stranded wire on 22–26 AWG [0.4–0.12 mm<sup>2</sup>] MTA-156 connectors.

Only one wire to be terminated into an IDC contact slot.

Mass termination of wire provides the lowest applied cost because it drastically reduces the labor content of virtually any cable or harness assembly required.

The wire-to-post connector housing material is flame retardant thermoplastic, either UL94V-2 or UL94V-0 rated.

A full line of .156 [3.96] centerline headers completes the system. Headers are available with straight or right-angle posts, in flat friction lock and shrouded styles. Headers are available in 2 through 24 positions.

**Note:** Refer to page 70 for approved wire listings.

### Performance Data\*

**Voltage Rating**—600 vac

**Current Rating**—7 amp max. for MTA-156 Connector

**Low-Level Resistance**—3.0 mΩ max. initial

**Dielectric Withstanding Voltage**—2200 vac/1 min.

**Insulation Resistance**—5000 MΩ min. initial

**Operating Temperature**—–55° C to +105° C

\*Refer to the Product Specification for additional electrical, mechanical and environmental performance tests and requirements.

### Technical Documents

#### Product Specification

108-1051 MTA-156 Connectors

#### Application Specifications

114-1020 MTA-156 Connectors, Posted Connectors and Card Edge Connectors

114-1032 MTA-156 Ribbon Cable Assembly

MTA-156  
.156 [3.96]





### MTA-156 Connector/Header Mateability Guide (Continued)

This matrix has been prepared to assist you, our customer, in defining the correct mating halves for the MTA-156 header and connector combination. Where a “Y” is indicated the combination is a valid mating pair. Where an “N” is indicated the combination is not acceptable for mating.

**Matrix for .000030  
[0.00076] Gold Plated  
Part Numbers**

| Connectors | Headers |        |        |        |        |        |        |        |        |        |        |        |        |        |        |        |
|------------|---------|--------|--------|--------|--------|--------|--------|--------|--------|--------|--------|--------|--------|--------|--------|--------|
|            | 641202  | 641203 | 641204 | 641207 | 641208 | 641209 | 641210 | 641210 | 641210 | 641210 | 641210 | 641210 | 641210 | 641210 | 641210 | 641210 |
| 641217     | Y       | Y      | Y      | N      | Y      | Y      | Y      | Y      | Y      | Y      | Y      | Y      | Y      | Y      | Y      | Y      |
| 641218     | Y       | Y      | Y      | N      | Y      | Y      | Y      | Y      | Y      | Y      | Y      | Y      | Y      | Y      | Y      | Y      |
| 641219     | Y       | Y      | Y      | N      | Y      | Y      | Y      | Y      | Y      | Y      | Y      | Y      | Y      | Y      | Y      | Y      |
| 641220     | Y       | Y      | Y      | N      | Y      | Y      | Y      | Y      | Y      | Y      | Y      | Y      | Y      | Y      | Y      | Y      |
| 641221     | Y       | Y      | Y      | N      | Y      | Y      | Y      | Y      | Y      | Y      | Y      | Y      | Y      | Y      | Y      | Y      |
| 641222     | Y       | Y      | Y      | Y      | Y      | Y      | Y      | Y      | Y      | Y      | Y      | Y      | Y      | Y      | Y      | Y      |
| 641223     | Y       | Y      | Y      | Y      | Y      | Y      | Y      | Y      | Y      | Y      | Y      | Y      | Y      | Y      | Y      | Y      |
| 641224     | Y       | Y      | Y      | Y      | Y      | Y      | Y      | Y      | Y      | Y      | Y      | Y      | Y      | Y      | Y      | Y      |
| 641225     | Y       | Y      | Y      | Y      | Y      | Y      | Y      | Y      | Y      | Y      | Y      | Y      | Y      | Y      | Y      | Y      |
| 641226     | Y       | Y      | Y      | Y      | Y      | Y      | Y      | Y      | Y      | Y      | Y      | Y      | Y      | Y      | Y      | Y      |
| 641227     | Y       | Y      | Y      | N      | Y      | Y      | Y      | Y      | Y      | Y      | Y      | Y      | Y      | Y      | Y      | Y      |
| 641228     | Y       | Y      | Y      | N      | Y      | Y      | Y      | Y      | Y      | Y      | Y      | Y      | Y      | Y      | Y      | Y      |
| 641229     | Y       | Y      | Y      | N      | Y      | Y      | Y      | Y      | Y      | Y      | Y      | Y      | Y      | Y      | Y      | Y      |
| 641230     | Y       | Y      | Y      | N      | Y      | Y      | Y      | Y      | Y      | Y      | Y      | Y      | Y      | Y      | Y      | Y      |
| 641231     | Y       | Y      | Y      | N      | Y      | Y      | Y      | Y      | Y      | Y      | Y      | Y      | Y      | Y      | Y      | Y      |
| 641232     | Y       | Y      | Y      | Y      | Y      | Y      | Y      | Y      | Y      | Y      | Y      | Y      | Y      | Y      | Y      | Y      |
| 641233     | Y       | Y      | Y      | Y      | Y      | Y      | Y      | Y      | Y      | Y      | Y      | Y      | Y      | Y      | Y      | Y      |
| 641234     | Y       | Y      | Y      | Y      | Y      | Y      | Y      | Y      | Y      | Y      | Y      | Y      | Y      | Y      | Y      | Y      |
| 641235     | Y       | Y      | Y      | Y      | Y      | Y      | Y      | Y      | Y      | Y      | Y      | Y      | Y      | Y      | Y      | Y      |
| 641236     | Y       | Y      | Y      | Y      | Y      | Y      | Y      | Y      | Y      | Y      | Y      | Y      | Y      | Y      | Y      | Y      |
| 644460     | Y       | Y      | Y      | N      | Y      | Y      | Y      | Y      | Y      | Y      | Y      | Y      | Y      | Y      | Y      | Y      |
| 644662     | Y       | Y      | Y      | N      | Y      | Y      | Y      | Y      | Y      | Y      | Y      | Y      | Y      | Y      | Y      | Y      |
| 644663     | Y       | Y      | Y      | N      | Y      | Y      | Y      | Y      | Y      | Y      | Y      | Y      | Y      | Y      | Y      | Y      |
| 644687     | Y       | Y      | Y      | Y      | Y      | Y      | Y      | Y      | Y      | Y      | Y      | Y      | Y      | Y      | Y      | Y      |
| 644718     | Y       | Y      | Y      | Y      | Y      | Y      | Y      | Y      | Y      | Y      | Y      | Y      | Y      | Y      | Y      | Y      |
| 644720     | Y       | Y      | Y      | N      | Y      | Y      | Y      | Y      | Y      | Y      | Y      | Y      | Y      | Y      | Y      | Y      |

**Matrix for .000015  
[0.00038] Gold Plated  
Part Numbers**

| Connectors | Headers |        |        |        |        |        |        |        |        |        |        |        |        |        |        |        |
|------------|---------|--------|--------|--------|--------|--------|--------|--------|--------|--------|--------|--------|--------|--------|--------|--------|
|            | 641113  | 641114 | 641115 | 641118 | 641119 | 641120 | 641121 | 641121 | 641121 | 641121 | 641121 | 641121 | 641121 | 641121 | 641121 | 641121 |
| 641148     | Y       | Y      | Y      | N      | Y      | Y      | Y      | Y      | Y      | Y      | Y      | Y      | Y      | Y      | Y      | Y      |
| 641149     | Y       | Y      | Y      | N      | Y      | Y      | Y      | Y      | Y      | Y      | Y      | Y      | Y      | Y      | Y      | Y      |
| 641150     | Y       | Y      | Y      | N      | Y      | Y      | Y      | Y      | Y      | Y      | Y      | Y      | Y      | Y      | Y      | Y      |
| 641151     | Y       | Y      | Y      | N      | Y      | Y      | Y      | Y      | Y      | Y      | Y      | Y      | Y      | Y      | Y      | Y      |
| 641152     | Y       | Y      | Y      | N      | Y      | Y      | Y      | Y      | Y      | Y      | Y      | Y      | Y      | Y      | Y      | Y      |
| 641153     | Y       | Y      | Y      | Y      | Y      | Y      | Y      | Y      | Y      | Y      | Y      | Y      | Y      | Y      | Y      | Y      |
| 641154     | Y       | Y      | Y      | Y      | Y      | Y      | Y      | Y      | Y      | Y      | Y      | Y      | Y      | Y      | Y      | Y      |
| 641155     | Y       | Y      | Y      | Y      | Y      | Y      | Y      | Y      | Y      | Y      | Y      | Y      | Y      | Y      | Y      | Y      |
| 641156     | Y       | Y      | Y      | Y      | Y      | Y      | Y      | Y      | Y      | Y      | Y      | Y      | Y      | Y      | Y      | Y      |
| 641157     | Y       | Y      | Y      | Y      | Y      | Y      | Y      | Y      | Y      | Y      | Y      | Y      | Y      | Y      | Y      | Y      |
| 641168     | Y       | Y      | Y      | N      | Y      | Y      | Y      | Y      | Y      | Y      | Y      | Y      | Y      | Y      | Y      | Y      |
| 641169     | Y       | Y      | Y      | N      | Y      | Y      | Y      | Y      | Y      | Y      | Y      | Y      | Y      | Y      | Y      | Y      |
| 641170     | Y       | Y      | Y      | N      | Y      | Y      | Y      | Y      | Y      | Y      | Y      | Y      | Y      | Y      | Y      | Y      |
| 641171     | Y       | Y      | Y      | N      | Y      | Y      | Y      | Y      | Y      | Y      | Y      | Y      | Y      | Y      | Y      | Y      |
| 641172     | Y       | Y      | Y      | N      | Y      | Y      | Y      | Y      | Y      | Y      | Y      | Y      | Y      | Y      | Y      | Y      |
| 641173     | Y       | Y      | Y      | Y      | Y      | Y      | Y      | Y      | Y      | Y      | Y      | Y      | Y      | Y      | Y      | Y      |
| 641174     | Y       | Y      | Y      | Y      | Y      | Y      | Y      | Y      | Y      | Y      | Y      | Y      | Y      | Y      | Y      | Y      |
| 641175     | Y       | Y      | Y      | Y      | Y      | Y      | Y      | Y      | Y      | Y      | Y      | Y      | Y      | Y      | Y      | Y      |
| 641176     | Y       | Y      | Y      | Y      | Y      | Y      | Y      | Y      | Y      | Y      | Y      | Y      | Y      | Y      | Y      | Y      |
| 641177     | Y       | Y      | Y      | Y      | Y      | Y      | Y      | Y      | Y      | Y      | Y      | Y      | Y      | Y      | Y      | Y      |
| 644284     | Y       | Y      | Y      | N      | Y      | Y      | Y      | Y      | Y      | Y      | Y      | Y      | Y      | Y      | Y      | Y      |
| 647478     | Y       | Y      | Y      | N      | Y      | Y      | Y      | Y      | Y      | Y      | Y      | Y      | Y      | Y      | Y      | Y      |
| 647479     | Y       | Y      | Y      | N      | Y      | Y      | Y      | Y      | Y      | Y      | Y      | Y      | Y      | Y      | Y      | Y      |
| 647496     | Y       | Y      | Y      | Y      | Y      | Y      | Y      | Y      | Y      | Y      | Y      | Y      | Y      | Y      | Y      | Y      |

**MTA-156 IDC Connectors—Closed End**

**Material and Finish**

**Housing** — UL94V-2 rated, nylon, see below for color; or UL94V-0 rated, nylon, black

**Contacts** — Phosphor bronze, post tin plated, .000030 [0.00076] or .000015 [.00038] post gold plated over nickel

**Color Coding by Wire Size for UL94V-2 Connectors**

- 26 AWG — Blue
- 24 AWG — White
- 22 AWG — Red
- 20 AWG — Yellow
- 18 AWG — Orange

**All Wire Sizes in UL94V-0** — Black

**Notes:**

1. Only connectors with locking ramp and without polarizing tabs mate with posted connectors on page 45.
2. Refer to pages 70 thru 74 for approved wire listing.
3. For strain reliefs and dust covers, see pages 40 and 41.
4. For keying plugs and panel mount end caps, see page 42.
5. Other circuit sizes are available upon request. Minimums may apply.
6. Connector circuits can be molded closed for keying purposes. Minimums may apply.
7. Where no part numbers appear in the chart, parts can be made available upon request. Minimums may apply.
8. To determine connector overall length (Dim. A), multiply .156 x the number of circuits. Example: .156 x 10 circuits equals 1.560 inches [39.62 mm].

**Closed End with Locking Ramp**



without Polarizing Tabs



with Polarizing Tabs

For mateability options, see matrix on pages 34 and 35.

Mating half visuals for Closed End Connectors with Locking Ramp, see pages 45 thru 48, 50, 52, and 53, (49 and 51 Front Bend Headers Only).

**Closed End without Locking Ramp**



without Polarizing Tabs



with Polarizing Tabs

For mateability options, see matrix on pages 34 and 35.

Mating half visuals for Closed End Connectors without Locking Ramp, see pages 46 thru 53.

MTA-156  
.156 [3.96]

**MTA-156 IDC Connectors—Closed End** (Continued)

**Connector Ordering Information**

The “Base Part Numbers” Chart at right shows the base part number and number of circuits available for the described connectors.

Prefixes and suffixes are determined by the number of circuit positions in the connector. For example, the complete part number for a 10-position closed end connector with locking ramp and without polarizing tabs for 18 AWG wire would be:

Base number **640426** plus prefix-and-suffix

**4- -0**

The correct ordering number is

**4-640426-0**

All part numbers in **bold face** are the RoHS equivalent version. Example:

| No. of Pos. | Lead Free RoHS Prefix/Suffix |
|-------------|------------------------------|
| 2           | 3-640426-2                   |
| 3           | 3-640426-3                   |
| 4           | 3-640426-4                   |
| 5           | 3-640426-5                   |
| 6           | 3-640426-6                   |
| 7           | 3-640426-7                   |
| 8           | 3-640426-8                   |
| 9           | 3-640426-9                   |
| 10          | 4-640426-0                   |
| 11          | 4-640426-1                   |
| 12          | 4-640426-2                   |
| 13          | 4-640426-3                   |
| 14          | 4-640426-4                   |
| 15          | 4-640426-5                   |
| 16          | 4-640426-6                   |
| 17          | 4-640426-7                   |
| 18          | 4-640426-8                   |
| 19          | 4-640426-9                   |
| 20          | 5-640426-0                   |
| 21          | 5-640426-1                   |
| 22          | 5-640426-2                   |
| 23          | 5-640426-3                   |
| 24          | 5-640426-4                   |

**Note:** All RoHS equivalent part numbers may not be available upon catalog release. If the number you need is not available, please contact Product Engineering to expedite your request.

**Base Part Numbers**

| Connector Type & Wire Size                             | Closed End with Locking Ramp |                       |                     |                       | Closed End without Locking Ramp |              |                     |              |
|--|------------------------------|-----------------------|---------------------|-----------------------|---------------------------------|--------------|---------------------|--------------|
|  | Without Tabs                 |                       | With Tabs           |                       | Without Tabs                    |              | With Tabs           |              |
|  | Connector Part Nos.          | Connector RoHS Equiv. | Connector Part Nos. | Connector RoHS Equiv. | Connector Part Nos.             | RoHS Equiv.  | Part Nos.           | RoHS Equiv.  |
| <b>Standard UL94V-2, Tin Plated</b>                    |                              |                       |                     |                       |                                 |              |                     |              |
| <b>18 AWG</b><br>0.8–0.9 mm <sup>2</sup>               | 640426                       | <b>32–54</b>          | 643817              | <b>32–54</b>          | 640431                          | <b>32–54</b> | 644461 <sup>1</sup> | <b>32–44</b> |
| <b>20 AWG</b><br>0.5–0.6 mm <sup>2</sup>               | 640427                       | <b>32–54</b>          | 643818              | <b>32–54</b>          | 640432                          | <b>32–54</b> | 644462 <sup>1</sup> | <b>32–44</b> |
| <b>22 AWG</b><br>0.3–0.4 mm <sup>2</sup>               | 640428                       | <b>32–54</b>          | 643819              | <b>32–54</b>          | 640433                          | <b>32–54</b> | 644463 <sup>1</sup> | <b>32–44</b> |
| <b>24 AWG</b><br>0.2 mm <sup>2</sup>                   | 640429                       | <b>32–54</b>          | 643820              | <b>32–54</b>          | 640434                          | <b>32–54</b> | 644464 <sup>1</sup> | <b>32–44</b> |
| <b>26 AWG</b><br>0.12–0.15 mm <sup>2</sup>             | 640430                       | <b>32–54</b>          | 643821              | <b>32–54</b>          | 640435                          | <b>32–54</b> | —                   | —            |
| <b>Tape Mounted on Reel UL94V-2, Tin Plated</b>        |                              |                       |                     |                       |                                 |              |                     |              |
| <b>18 AWG</b><br>0.8–0.9 mm <sup>2</sup>               | 640472                       | <b>32–54</b>          | 644878              | <b>32–54</b>          | 640477                          | <b>32–54</b> | —                   | —            |
| <b>20 AWG</b><br>0.5–0.6 mm <sup>2</sup>               | 640473                       | <b>32–54</b>          | —                   | —                     | 640478                          | <b>32–54</b> | —                   | —            |
| <b>22 AWG</b><br>0.3–0.4 mm <sup>2</sup>               | 640474                       | <b>32–54</b>          | 644783              | <b>32–54</b>          | 640479                          | <b>32–54</b> | 644791 <sup>1</sup> | <b>32–44</b> |
| <b>24 AWG</b><br>0.2 mm <sup>2</sup>                   | 640475                       | <b>32–54</b>          | —                   | —                     | 640480                          | <b>32–54</b> | —                   | —            |
| <b>26 AWG</b><br>0.12–0.15 mm <sup>2</sup>             | 640476                       | <b>32–54</b>          | —                   | —                     | 640481                          | <b>32–54</b> | —                   | —            |
| <b>Standard UL94V-2, .000030 [0.00076] Gold Plated</b> |                              |                       |                     |                       |                                 |              |                     |              |
| <b>18 AWG</b><br>0.8–0.9 mm <sup>2</sup>               | 641217                       | <b>32–54</b>          | 644460 <sup>1</sup> | <b>32–42</b>          | 641222                          | <b>32–54</b> | —                   | —            |
| <b>20 AWG</b><br>0.5–0.6 mm <sup>2</sup>               | 641218                       | <b>32–54</b>          | 644663 <sup>1</sup> | <b>32–42</b>          | 641223                          | <b>32–54</b> | —                   | —            |
| <b>22 AWG</b><br>0.3–0.4 mm <sup>2</sup>               | 641219                       | <b>32–54</b>          | 644662 <sup>1</sup> | <b>32–42</b>          | 641224                          | <b>32–54</b> | 644687 <sup>1</sup> | <b>32–44</b> |
| <b>24 AWG</b><br>0.2 mm <sup>2</sup>                   | 641220                       | <b>32–54</b>          | —                   | —                     | 641225                          | <b>32–54</b> | —                   | —            |
| <b>26 AWG</b><br>0.12–0.15 mm <sup>2</sup>             | 641221                       | <b>32–54</b>          | —                   | —                     | 641226                          | <b>32–54</b> | —                   | —            |
| <b>Standard UL94V-2, .000015 [0.00038] Gold Plated</b> |                              |                       |                     |                       |                                 |              |                     |              |
| <b>18 AWG</b><br>0.8–0.9 mm <sup>2</sup>               | 641148                       | <b>32–54</b>          | 644284 <sup>1</sup> | <b>32–42</b>          | 641153                          | <b>32–54</b> | —                   | —            |
| <b>20 AWG</b><br>0.5–0.6 mm <sup>2</sup>               | 641149                       | <b>32–54</b>          | —                   | —                     | 641154                          | <b>32–54</b> | —                   | —            |
| <b>22 AWG</b><br>0.3–0.4 mm <sup>2</sup>               | 641150                       | <b>32–54</b>          | 647478 <sup>1</sup> | <b>32–42</b>          | 641155                          | <b>32–54</b> | —                   | —            |
| <b>24 AWG</b><br>0.2 mm <sup>2</sup>                   | 641151                       | <b>32–54</b>          | —                   | —                     | 641156                          | <b>32–54</b> | —                   | —            |
| <b>26 AWG</b><br>0.12–0.15 mm <sup>2</sup>             | 641152                       | <b>32–54</b>          | —                   | —                     | 641157                          | <b>32–54</b> | —                   | —            |
| <b>Standard UL94V-0, Tin Plated (Black in color)</b>   |                              |                       |                     |                       |                                 |              |                     |              |
| <b>18 AWG</b><br>0.8–0.9 mm <sup>2</sup>               | 644860 <sup>1</sup>          | <b>32–42</b>          | —                   | —                     | 644502 <sup>1</sup>             | <b>32–42</b> | 644082 <sup>1</sup> | <b>32–42</b> |
| <b>22 AWG</b><br>0.3–0.4 mm <sup>2</sup>               | —                            | —                     | —                   | —                     | 644501 <sup>1</sup>             | <b>32–42</b> | 644566 <sup>1</sup> | <b>32–42</b> |

<sup>1</sup> Other circuit sizes are available upon request. Minimums may apply.

**Note:** Blocked circuit configurations are available upon request. Contact product engineer or product manager for details. Minimums may apply.

**MTA-156 IDC Connectors—Feed-Thru**

**Material and Finish**

**Housing** — UL94V-2 rated, nylon, see below for color; or UL94V-0 rated, nylon, black

**Contacts** — Phosphor bronze; post tin plated, .000030 [.00076] or .000015 [.00038] post gold plated over nickel

**Color Coding by Wire Size for UL94V-2 Connectors**

- 26 AWG — Blue
- 24 AWG — White
- 22 AWG — Red
- 20 AWG — Yellow
- 18 AWG — Orange

**All Wire Sizes in UL94V-0** — Black

**Notes:**

1. Only connectors with locking ramp and without polarizing tabs mate with posted connectors on page 45.
2. Refer to pages 70 thru 74 for approved wire listing.
3. For strain reliefs and dust covers, see pages 40 and 41.
4. For keying plugs and panel mount end caps, see page 42.
5. Other circuit sizes are available upon request. Minimums may apply.
6. Connector circuits can be molded closed for keying purposes. Minimums may apply.
7. Where no part numbers appear in the chart, parts can be made available upon request. Minimums may apply.
8. To determine connector overall length (Dim. A), multiply .156 x the number of circuits. Example: .156 x 10 circuits equals 1.560 inches [39.62 mm].

**Feed-Thru with Locking Ramp**



without Polarizing Tabs

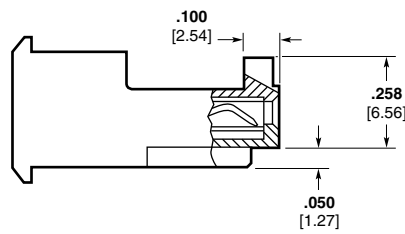

with Polarizing Tabs

For mateability options, see matrix on pages 34 and 35.

Mating half visuals for Feed-Thru Connectors with Locking Ramp, see pages 45 thru 48, 50, 52, and 53, (49 and 51 Front Bend Headers Only).

**Feed-Thru without Locking Ramp**

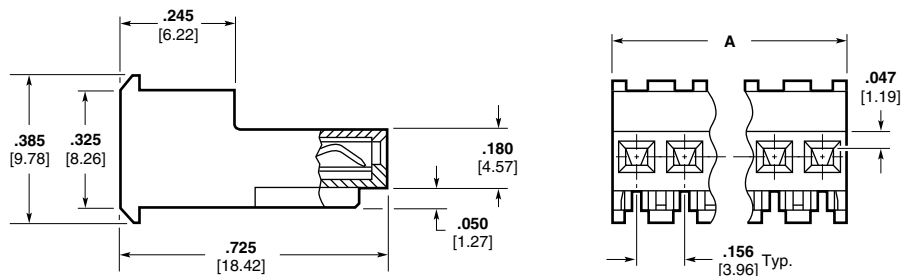

without Polarizing Tabs



with Polarizing Tabs

For mateability options, see matrix on pages 34 and 35.

Mating half visuals for Feed-Thru Connectors without Locking Ramp, see pages 46 thru 53.

MTA-156  
.156 [3.96]

## MTA-156 IDC Connectors—Feed-Thru (Continued)

### Connector Ordering Information

The “Base Part Numbers” Chart at right shows the base part number and number of circuits available for the described connectors.

Prefixes and suffixes are determined by the number of circuit positions in the connector. For example, the complete part number for a 10-position feed-thru connector with locking ramp and without polarizing tabs for 18 AWG wire would be:

Base number **640599** plus  
prefix-and-suffix  
**4- -0**

The correct ordering number is

**4-640599-0**

The part numbers in **bold face** are the RoHS equivalent version. Example:

| No. of Pos. | Lead Free RoHS Prefix/Suffix |
|-------------|------------------------------|
| 2           | 3-640599-2                   |
| 3           | 3-640599-3                   |
| 4           | 3-640599-4                   |
| 5           | 3-640599-5                   |
| 6           | 3-640599-6                   |
| 7           | 3-640599-7                   |
| 8           | 3-640599-8                   |
| 9           | 3-640599-9                   |
| 10          | 4-640599-0                   |
| 11          | 4-640599-1                   |
| 12          | 4-640599-2                   |
| 13          | 4-640599-3                   |
| 14          | 4-640599-4                   |
| 15          | 4-640599-5                   |
| 16          | 4-640599-6                   |
| 17          | 4-640599-7                   |
| 18          | 4-640599-8                   |
| 19          | 4-640599-9                   |
| 20          | 5-640599-0                   |
| 21          | 5-640599-1                   |
| 22          | 5-640599-2                   |
| 23          | 5-640599-3                   |
| 24          | 5-640599-4                   |

**Note:** All RoHS equivalent part numbers may not be available upon catalog release. If the number you need is not available, please contact Product Engineering to expedite your request.

### Base Part Numbers

| Connector Type & Wire Size                            | Feed-Thru with Locking Ramp |                       |                     |              | Feed-Thru without Locking Ramp |              |                     |              |
|---|-----------------------------|-----------------------|---------------------|--------------|--------------------------------|--------------|---------------------|--------------|
|   | Without Tabs                |                       | With Tabs           |              | Without Tabs                   |              | With Tabs           |              |
|   | Connector Part Nos.         | Connector RoHS Equiv. | Connector Part Nos. | RoHS Equiv.  | Connector Part Nos.            | RoHS Equiv.  | Part Nos.           | RoHS Equiv.  |
| <b>Standard UL94V-2, Tin Plated</b>                   |                             |                       |                     |              |                                |              |                     |              |
| <b>18 AWG</b><br>0.8–0.9 mm <sup>2</sup>              | 640599                      | <b>32-54</b>          | 644465 <sup>1</sup> | <b>32-44</b> | 640604                         | <b>32-54</b> | 644469 <sup>1</sup> | <b>32-44</b> |
| <b>20 AWG</b><br>0.5–0.6 mm <sup>2</sup>              | 640600                      | <b>32-54</b>          | 644466 <sup>1</sup> | <b>32-44</b> | 640605                         | <b>32-54</b> | 644470 <sup>1</sup> | <b>32-44</b> |
| <b>22 AWG</b><br>0.3–0.4 mm <sup>2</sup>              | 640601                      | <b>32-54</b>          | 644467 <sup>1</sup> | <b>32-44</b> | 640606                         | <b>32-54</b> | 644471 <sup>1</sup> | <b>32-44</b> |
| <b>24 AWG</b><br>0.2 mm <sup>2</sup>                  | 640602                      | <b>32-54</b>          | 644468 <sup>1</sup> | <b>32-44</b> | 640607                         | <b>32-54</b> | 644472 <sup>1</sup> | <b>32-44</b> |
| <b>26 AWG</b><br>0.12–0.15 mm <sup>2</sup>            | 640595                      | <b>32-54</b>          | —                   | —            | 640608                         | <b>32-54</b> | —                   | —            |
| <b>Tape Mounted on Reel UL94V-2, Tin Plated</b>       |                             |                       |                     |              |                                |              |                     |              |
| <b>18 AWG</b><br>0.8–0.9 mm <sup>2</sup>              | 641302                      | <b>32-54</b>          | —                   | —            | 641306                         | <b>32-54</b> | —                   | —            |
| <b>20 AWG</b><br>0.5–0.6 mm <sup>2</sup>              | 641303                      | <b>32-54</b>          | —                   | —            | 641307                         | <b>32-54</b> | —                   | —            |
| <b>22 AWG</b><br>0.3–0.4 mm <sup>2</sup>              | 641304                      | <b>32-54</b>          | —                   | —            | 641308                         | <b>32-54</b> | —                   | —            |
| <b>24 AWG</b><br>0.2 mm <sup>2</sup>                  | 641305                      | <b>32-54</b>          | —                   | —            | 641309                         | <b>32-54</b> | —                   | —            |
| <b>26 AWG</b><br>0.12–0.15 mm <sup>2</sup>            | 641301                      | <b>32-54</b>          | —                   | —            | 641310                         | <b>32-54</b> | —                   | —            |
| <b>Standard UL94V-2, .00003 [.00076] Gold Plated</b>  |                             |                       |                     |              |                                |              |                     |              |
| <b>18 AWG</b><br>0.8–0.9 mm <sup>2</sup>              | 641227                      | <b>32-54</b>          | 644718 <sup>1</sup> | <b>32-44</b> | 641232                         | <b>32-54</b> | —                   | —            |
| <b>20 AWG</b><br>0.5–0.6 mm <sup>2</sup>              | 641228                      | <b>32-54</b>          | —                   | —            | 641233                         | <b>32-54</b> | —                   | —            |
| <b>22 AWG</b><br>0.3–0.4 mm <sup>2</sup>              | 641229                      | <b>32-54</b>          | 644720 <sup>1</sup> | <b>32-44</b> | 641234                         | <b>32-54</b> | —                   | —            |
| <b>24 AWG</b><br>0.2 mm <sup>2</sup>                  | 641230                      | <b>32-54</b>          | —                   | —            | 641235                         | <b>32-54</b> | —                   | —            |
| <b>26 AWG</b><br>0.12–0.15 mm <sup>2</sup>            | 641231                      | <b>32-54</b>          | —                   | —            | 641236                         | <b>32-54</b> | —                   | —            |
| <b>Standard UL94V-2, .000015 [.00038] Gold Plated</b> |                             |                       |                     |              |                                |              |                     |              |
| <b>18 AWG</b><br>0.8–0.9 mm <sup>2</sup>              | 641168                      | <b>32-54</b>          | 647479 <sup>1</sup> | <b>32-42</b> | 641173                         | <b>32-54</b> | —                   | —            |
| <b>20 AWG</b><br>0.5–0.6 mm <sup>2</sup>              | 641169                      | <b>32-54</b>          | —                   | —            | 641174                         | <b>32-54</b> | —                   | —            |
| <b>22 AWG</b><br>0.3–0.4 mm <sup>2</sup>              | 641170                      | <b>32-54</b>          | 647496 <sup>1</sup> | <b>32-42</b> | 641175                         | <b>32-54</b> | —                   | —            |
| <b>24 AWG</b><br>0.2 mm <sup>2</sup>                  | 641171                      | <b>32-54</b>          | —                   | —            | 641176                         | <b>32-54</b> | —                   | —            |
| <b>26 AWG</b><br>0.12–0.15 mm <sup>2</sup>            | 641172                      | <b>32-54</b>          | —                   | —            | 641177                         | <b>32-54</b> | —                   | —            |
| <b>Standard UL94V-0, Tin Plated</b>                   |                             |                       |                     |              |                                |              |                     |              |
| <b>18 AWG</b><br>0.8–0.9 mm <sup>2</sup>              | —                           | —                     | —                   | —            | 644567 <sup>1</sup>            | <b>32-42</b> | 644570 <sup>1</sup> | <b>32-42</b> |
| <b>22 AWG</b><br>0.3–0.4 mm <sup>2</sup>              | —                           | —                     | —                   | —            | 644569 <sup>1</sup>            | <b>32-42</b> | 644572 <sup>1</sup> | <b>32-42</b> |

<sup>1</sup> Other circuit sizes are available upon request. Minimums may apply.

**Note:** Blocked circuit configurations are available upon request. Contact product engineer or product manager for details. Minimums may apply.

MTA-156  
.156 [3.96]

**MTA-156 Connector Accessories**

**Closed End Covers**

**Material (RoHS Compliant)**

**Strain Relief Covers** — UL94V-2 rated, nylon, white

**Dust Covers** — UL94V-0 rated, polyester, white

**Strain Relief Covers**



Note: This portion of front locking bar may or may not be present

**Dust Covers**



**Base Part Numbers**

| Closed End           |                 |                 |                 |
|----------------------|-----------------|-----------------|-----------------|
| Strain Relief Covers |                 | Dust Covers     |                 |
| Cover Part Nos.      | No. of Circuits | Cover Part Nos. | No. of Circuits |
| 643067               | 2-24            | 640551          | 2-24            |

**Feed-Thru Covers**

**Material (RoHS Compliant)**

**Strain Relief Covers** — UL94V-2 rated, nylon, white

**Dust Covers** — UL94V-0 rated, polyester, white

**Strain Relief Covers**



Note: This portion of front locking bar may or may not be present

**Dust Covers**



**Base Part Numbers**

| Feed-Thru            |                 |                 |                 |
|----------------------|-----------------|-----------------|-----------------|
| Strain Relief Covers |                 | Dust Covers     |                 |
| Cover Part Nos.      | No. of Circuits | Cover Part Nos. | No. of Circuits |
| 643071               | 2-24            | 640643          | 2-24            |

**Cover Ordering Information**

The "Base Part Numbers" Chart at right shows the base part number and number of circuits available for the described cover.

Prefixes and suffixes are determined by the number of circuit positions in the cover. For example, the complete part number for a 10-position closed-end strain relief cover would be:

Base number **643067** plus prefix-and-suffix

**1 — -0**

The correct ordering number is

**1-643067-0**

**Cover Length**

| No. of Circuits | Dim. A         | Prefix/Suffix |
|-----------------|----------------|---------------|
| 2               | .312<br>7.92   | -2            |
| 3               | .468<br>11.89  | -3            |
| 4               | .624<br>15.85  | -4            |
| 5               | .780<br>19.81  | -5            |
| 6               | .936<br>23.77  | -6            |
| 7               | 1.092<br>27.74 | -7            |
| 8               | 1.248<br>31.7  | -8            |
| 9               | 1.404<br>35.66 | -9            |

| No. of Circuits | Dim. A         | Prefix/Suffix |
|-----------------|----------------|---------------|
| 10              | 1.560<br>39.62 | 1- -0         |
| 11              | 1.716<br>43.59 | 1- -1         |
| 12              | 1.872<br>47.55 | 1- -2         |
| 13              | 2.028<br>51.51 | 1- -3         |
| 14              | 2.184<br>55.47 | 1- -4         |
| 15              | 2.340<br>59.44 | 1- -5         |
| 16              | 2.496<br>63.4  | 1- -6         |
| 17              | 2.652<br>67.36 | 1- -7         |

| No. of Circuits | Dim. A         | Prefix/Suffix |
|-----------------|----------------|---------------|
| 18              | 2.808<br>71.32 | 1- -8         |
| 19              | 2.964<br>75.29 | 1- -9         |
| 20              | 3.120<br>79.25 | 2- -0         |
| 21              | 3.276<br>83.21 | 2- -1         |
| 22              | 3.432<br>87.17 | 2- -2         |
| 23              | 3.588<br>91.14 | 2- -3         |
| 24              | 3.744<br>95.1  | 2- -4         |

MTA-156  
.156 [3.96]



## MTA-156 Connector Accessories (Continued)

### Replacement IDC Contacts

#### Material and Finish

**Contacts** — Phosphor bronze, post tin plated; .000030 [0.00076] or .000015 [0.00038] post gold plated over nickel

**Note:** Tyco Electronics does not recommend terminating an MTA contact more than one time. Use replacement contacts when required for field repairs or wire changes.



| Wire Size |                 | Part Numbers |                                  |                                  |
|-----------|-----------------|--------------|----------------------------------|----------------------------------|
| AWG       | mm <sup>2</sup> | Tin Plated   | .000030 [0.00076]<br>Gold Plated | .000015 [0.00038]<br>Gold Plated |
| 18        | 0.8–0.9         | 640631-3     | 641143-4                         | 641143-3                         |
| 20        | 0.5–0.6         | 640632–3     | 641144-4                         | 641144-3                         |
| 22        | 0.3–0.4         | 640633-3     | 641145-4                         | 641145-3                         |
| 24        | 0.2             | 640634-3     | 641146-4                         | 641146-3                         |
| 26        | 0.12–0.15       | 640635-3     | 641147-4                         | 641147-3                         |

### Crimp Snap-in Contacts

#### Material and Finish

**Contacts** — Phosphor bronze, tin plated



| Wire Size |                 | Part Nos.    |          |
|-----------|-----------------|--------------|----------|
| AWG       | mm <sup>2</sup> | Loose Piece* | Strip**  |
| 26–22     | .12–0.3         | 640557-3     | 640556-3 |
| 22–18     | 0.3–0.9         | 640559-3     | 640558-3 |

\*Hand Tool No. 59837-1 (408-6528)  
\*\*AMP-O-LECTRIC Model "G" Termination Machine (Request Catalog 65828)  
**Note:** Requires applicator. For part number, call Technical Support.

Special applications for crimp snap-in contacts are:

1. Double wire per contact
2. Coax or shielded wire
3. Mixed wire size in same connector

**Note:** Only one crimp snap-in contact per connector.

**MTA-156 Connector Accessories** (Continued)

**Keying Plugs**

**Material (RoHS Compliant)**

UL94V-2 rated, nylon, natural color

**Note:** Removal of contact is not necessary when using keying plug.

**Loose Piece**

**Part No. 640629-1 (Flush)**  
Used with keyed headers



**On Carrier Strip**

**Part No. 641623-1 (Flush)**  
(10 per strip)



**Part No. 640630-1 (Long Nose)**  
Used with staked post



**Panel Mount End Caps**

**Part No. 641440-1**  
**Part No. 641533-1**  
(2-position only)

**Material (RoHS Compliant)**

UL94V-2 rated, nylon, black

**Notes:**

- Both left-hand and right-hand end caps are attached by a connecting tab. This tab must be broken off prior to installing on connector.
- For best results attach panel mount end caps to the MTA-156 (IDC) connectors shown on pages 36 thru 39. While not preferred, panel mount end caps can be attached to MTA-156 (IDC) posted connector on page 45.

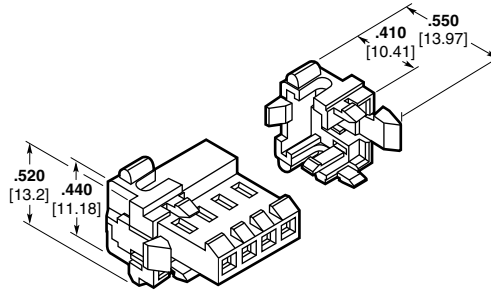

**3- thru 24-Position**  
**641440-1**  
See Note 1

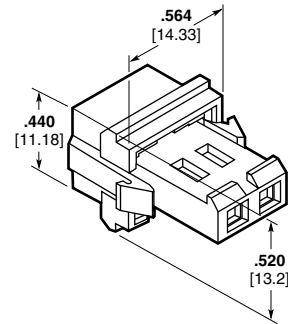

**Two-Position Only**  
**641533-1**

| No. of Pos. | Dim. A         |
|-------------|----------------|
| 3           | .736<br>18.69  |
| 4           | .892<br>22.66  |
| 6           | 1.204<br>30.58 |
| 9           | 1.672<br>42.47 |
| 12          | 2.140<br>54.36 |
| 15          | 2.608<br>66.24 |
| 24          | 4.012<br>101.9 |

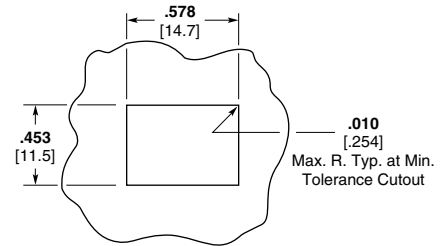

**Recommended Panel Cutout**  
(Recommended Panel Thickness .062 [1.57] to .067 [1.70] max.)

MTA-156  
.156 [3.96]

## MTA-156 Posted Connector/Connector Mateability Guide

### Matrix for Tin Plated Part Numbers

This matrix has been prepared to assist you, our customer, in defining the correct mating halves for the MTA-156 posted connector and connector combination. Where a "Y" is indicated the combination is a valid mating pair. Where an "N" is indicated the combination is not acceptable for mating.

| Connectors | Posted Connectors |        |        |        |        |        |        |        |        |        |
|------------|-------------------|--------|--------|--------|--------|--------|--------|--------|--------|--------|
|            | 641436            | 641436 | 641437 | 641438 | 641439 | 641522 | 641523 | 641524 | 641525 | 641526 |
| 640426     | Y                 | Y      | Y      | Y      | Y      | Y      | Y      | Y      | Y      | Y      |
| 640427     | Y                 | Y      | Y      | Y      | Y      | Y      | Y      | Y      | Y      | Y      |
| 640428     | Y                 | Y      | Y      | Y      | Y      | Y      | Y      | Y      | Y      | Y      |
| 640429     | Y                 | Y      | Y      | Y      | Y      | Y      | Y      | Y      | Y      | Y      |
| 640430     | Y                 | Y      | Y      | Y      | Y      | Y      | Y      | Y      | Y      | Y      |
| 640431     | N                 | N      | N      | N      | N      | N      | N      | N      | N      | N      |
| 640432     | N                 | N      | N      | N      | N      | N      | N      | N      | N      | N      |
| 640433     | N                 | N      | N      | N      | N      | N      | N      | N      | N      | N      |
| 640434     | N                 | N      | N      | N      | N      | N      | N      | N      | N      | N      |
| 640435     | N                 | N      | N      | N      | N      | N      | N      | N      | N      | N      |
| 640472     | Y                 | Y      | Y      | Y      | Y      | Y      | Y      | Y      | Y      | Y      |
| 640473     | Y                 | Y      | Y      | Y      | Y      | Y      | Y      | Y      | Y      | Y      |
| 640474     | Y                 | Y      | Y      | Y      | Y      | Y      | Y      | Y      | Y      | Y      |
| 640475     | Y                 | Y      | Y      | Y      | Y      | Y      | Y      | Y      | Y      | Y      |
| 640476     | Y                 | Y      | Y      | Y      | Y      | Y      | Y      | Y      | Y      | Y      |
| 640477     | N                 | N      | N      | N      | N      | N      | N      | N      | N      | N      |
| 640478     | N                 | N      | N      | N      | N      | N      | N      | N      | N      | N      |
| 640479     | N                 | N      | N      | N      | N      | N      | N      | N      | N      | N      |
| 640480     | N                 | N      | N      | N      | N      | N      | N      | N      | N      | N      |
| 640481     | N                 | N      | N      | N      | N      | N      | N      | N      | N      | N      |
| 640595     | Y                 | Y      | Y      | Y      | Y      | Y      | Y      | Y      | Y      | Y      |
| 640599     | Y                 | Y      | Y      | Y      | Y      | Y      | Y      | Y      | Y      | Y      |
| 640600     | Y                 | Y      | Y      | Y      | Y      | Y      | Y      | Y      | Y      | Y      |
| 640601     | Y                 | Y      | Y      | Y      | Y      | Y      | Y      | Y      | Y      | Y      |
| 640602     | Y                 | Y      | Y      | Y      | Y      | Y      | Y      | Y      | Y      | Y      |
| 640604     | N                 | N      | N      | N      | N      | N      | N      | N      | N      | N      |
| 640605     | N                 | N      | N      | N      | N      | N      | N      | N      | N      | N      |
| 640606     | N                 | N      | N      | N      | N      | N      | N      | N      | N      | N      |
| 640607     | N                 | N      | N      | N      | N      | N      | N      | N      | N      | N      |
| 640608     | N                 | N      | N      | N      | N      | N      | N      | N      | N      | N      |
| 641301     | Y                 | Y      | Y      | Y      | Y      | Y      | Y      | Y      | Y      | Y      |
| 641302     | Y                 | Y      | Y      | Y      | Y      | Y      | Y      | Y      | Y      | Y      |
| 641303     | Y                 | Y      | Y      | Y      | Y      | Y      | Y      | Y      | Y      | Y      |
| 641304     | Y                 | Y      | Y      | Y      | Y      | Y      | Y      | Y      | Y      | Y      |
| 641305     | Y                 | Y      | Y      | Y      | Y      | Y      | Y      | Y      | Y      | Y      |
| 641306     | N                 | N      | N      | N      | N      | N      | N      | N      | N      | N      |
| 641307     | N                 | N      | N      | N      | N      | N      | N      | N      | N      | N      |
| 641308     | N                 | N      | N      | N      | N      | N      | N      | N      | N      | N      |
| 641309     | N                 | N      | N      | N      | N      | N      | N      | N      | N      | N      |
| 641310     | N                 | N      | N      | N      | N      | N      | N      | N      | N      | N      |
| 643817     | N                 | N      | N      | N      | N      | N      | N      | N      | N      | N      |
| 643818     | N                 | N      | N      | N      | N      | N      | N      | N      | N      | N      |
| 643819     | N                 | N      | N      | N      | N      | N      | N      | N      | N      | N      |
| 643820     | N                 | N      | N      | N      | N      | N      | N      | N      | N      | N      |
| 643821     | N                 | N      | N      | N      | N      | N      | N      | N      | N      | N      |
| 644082     | N                 | N      | N      | N      | N      | N      | N      | N      | N      | N      |
| 644461     | N                 | N      | N      | N      | N      | N      | N      | N      | N      | N      |
| 644462     | N                 | N      | N      | N      | N      | N      | N      | N      | N      | N      |
| 644463     | N                 | N      | N      | N      | N      | N      | N      | N      | N      | N      |
| 644464     | N                 | N      | N      | N      | N      | N      | N      | N      | N      | N      |
| 644465     | N                 | N      | N      | N      | N      | N      | N      | N      | N      | N      |
| 644466     | N                 | N      | N      | N      | N      | N      | N      | N      | N      | N      |
| 644467     | N                 | N      | N      | N      | N      | N      | N      | N      | N      | N      |
| 644468     | N                 | N      | N      | N      | N      | N      | N      | N      | N      | N      |
| 644469     | N                 | N      | N      | N      | N      | N      | N      | N      | N      | N      |
| 644470     | N                 | N      | N      | N      | N      | N      | N      | N      | N      | N      |
| 644471     | N                 | N      | N      | N      | N      | N      | N      | N      | N      | N      |
| 644472     | N                 | N      | N      | N      | N      | N      | N      | N      | N      | N      |
| 644501     | N                 | N      | N      | N      | N      | N      | N      | N      | N      | N      |
| 644502     | N                 | N      | N      | N      | N      | N      | N      | N      | N      | N      |
| 644566     | N                 | N      | N      | N      | N      | N      | N      | N      | N      | N      |
| 644567     | N                 | N      | N      | N      | N      | N      | N      | N      | N      | N      |
| 644569     | N                 | N      | N      | N      | N      | N      | N      | N      | N      | N      |
| 644570     | N                 | N      | N      | N      | N      | N      | N      | N      | N      | N      |
| 644572     | N                 | N      | N      | N      | N      | N      | N      | N      | N      | N      |
| 644783     | N                 | N      | N      | N      | N      | N      | N      | N      | N      | N      |
| 644791     | N                 | N      | N      | N      | N      | N      | N      | N      | N      | N      |
| 644860     | Y                 | Y      | Y      | Y      | Y      | Y      | Y      | Y      | Y      | Y      |
| 644878     | N                 | N      | N      | N      | N      | N      | N      | N      | N      | N      |

### MTA-156 Posted Connector/Connector Mateability Guide (Continued)

This matrix has been prepared to assist you, our customer, in defining the correct mating halves for the MTA-156 posted connector and connector combination. Where a "Y" is indicated the combination is a valid mating pair. Where an "N" is indicated the combination is not acceptable for mating.

**Matrix for .000030  
[0.00076] Gold Plated  
Part Numbers**

**Posted Connectors**

|        | 644807 | 644809 | 644812 | 644814 |
|--------|--------|--------|--------|--------|
| 641217 | Y      | Y      | Y      | Y      |
| 641218 | Y      | Y      | Y      | Y      |
| 641219 | Y      | Y      | Y      | Y      |
| 641220 | Y      | Y      | Y      | Y      |
| 641221 | Y      | Y      | Y      | Y      |
| 641222 | N      | N      | N      | N      |
| 641223 | N      | N      | N      | N      |
| 641224 | N      | N      | N      | N      |
| 641225 | N      | N      | N      | N      |
| 641226 | N      | N      | N      | N      |
| 641227 | Y      | Y      | Y      | Y      |
| 641228 | Y      | Y      | Y      | Y      |
| 641229 | Y      | Y      | Y      | Y      |
| 641230 | Y      | Y      | Y      | Y      |
| 641231 | Y      | Y      | Y      | Y      |
| 641232 | N      | N      | N      | N      |
| 641233 | N      | N      | N      | N      |
| 641234 | N      | N      | N      | N      |
| 641235 | N      | N      | N      | N      |
| 641236 | N      | N      | N      | N      |
| 644460 | N      | N      | N      | N      |
| 644662 | N      | N      | N      | N      |
| 644663 | N      | N      | N      | N      |
| 644687 | N      | N      | N      | N      |
| 644718 | N      | N      | N      | N      |
| 644720 | N      | N      | N      | N      |

Connectors

**Matrix for .000015  
[0.00038] Gold Plated  
Part Numbers**

**Posted Connectors**

|        | 643895 | 647476 | 647481 | 647497 |
|--------|--------|--------|--------|--------|
| 641148 | Y      | Y      | Y      | Y      |
| 641149 | Y      | Y      | Y      | Y      |
| 641150 | Y      | Y      | Y      | Y      |
| 641151 | Y      | Y      | Y      | Y      |
| 641152 | Y      | Y      | Y      | Y      |
| 641153 | N      | N      | N      | N      |
| 641154 | N      | N      | N      | N      |
| 641155 | N      | N      | N      | N      |
| 641156 | N      | N      | N      | N      |
| 641157 | N      | N      | N      | N      |
| 641168 | Y      | Y      | Y      | Y      |
| 641169 | Y      | Y      | Y      | Y      |
| 641170 | Y      | Y      | Y      | Y      |
| 641171 | Y      | Y      | Y      | Y      |
| 641172 | Y      | Y      | Y      | Y      |
| 641173 | N      | N      | N      | N      |
| 641174 | N      | N      | N      | N      |
| 641175 | N      | N      | N      | N      |
| 641176 | N      | N      | N      | N      |
| 641177 | N      | N      | N      | N      |
| 644284 | N      | N      | N      | N      |
| 647478 | N      | N      | N      | N      |
| 647479 | N      | N      | N      | N      |
| 647496 | N      | N      | N      | N      |

Connectors

MTA-156  
.156 [3.96]

**MTA-156 IDC Posted Connectors (Wire-to-Wire)—Closed End, Feed-Thru**

**Material and Finish**

**Housing** — UL 94V-2 rated, nylon, see chart for color

**Contacts** — Copper alloy, post tin or .000030 [.00076] gold plated over nickel



**Notes:**

1. Mating half visuals - pages 36 thru 39.
2. Strain relief & dust covers - pages 40 & 41.
3. Approved wire listing - page 70.

**Connector Ordering Information**

The "Base Part Numbers" Chart at right shows the base part number and number of circuits available for the described connectors.

Prefixes and suffixes are determined by the number of circuit positions in the connector. For example, the complete part number for a 12-position closed end connector for 18 AWG wire would be:

Base number **641435** plus prefix-and-suffix **4- -2**

The correct ordering number is **4-641435-2**

See page 15 for an explanation of RoHS lead free equivalents.

**Note:** All RoHS equivalent part numbers may not be available upon catalog release. If the number you need is not available, please contact Product Engineering to expedite your request.

**Color Coding by Wire Size for UL 94V-2 Connectors**

- 18 AWG — Orange
- 20 AWG — Yellow
- 22 AWG — Red
- 24 AWG — White
- 26 AWG — Blue

**Performance Data**

**Voltage Rating** — 600 VAC

**Current Rating** — 7 amp max.

**Low-Level Resistance** — 7 mΩ max. initial

**Dielectric Withstanding Voltage** — 1500 VAC/1 min.

**Insulation Resistance** — 5000 MΩ min. initial

**Operating Temperature** — -55° C to +105° C

**Base Part Numbers**

| Connector Type & Wire Size                              | Closed End Connector <sup>1</sup> |                                | Feed-Thru Connector <sup>1</sup> |                                |
|---|-----------------------------------|--------------------------------|----------------------------------|--------------------------------|
|   | Part Nos.                         | RoHS Equiv.                    | Part Nos.                        | RoHS Equiv.                    |
| <b>Standard UL 94V-2, Tin Plated</b>                    |                                   |                                |                                  |                                |
| 18 AWG<br>0.8-0.9 mm <sup>2</sup>                       | 641435                            | 32, 33, 34, 36, 39, 42, 45, 54 | 641522                           | 32, 33, 34, 36, 39, 42, 45, 54 |
| 20 AWG<br>0.5-0.6 mm <sup>2</sup>                       | 641436                            | 32, 33, 34, 36, 39, 42, 45, 54 | 641523                           | 32, 33, 34, 36, 39, 42, 45, 54 |
| 22 AWG<br>0.3-0.4 mm <sup>2</sup>                       | 641437                            | 32, 33, 34, 36, 39, 42, 45, 54 | 641524                           | 32, 33, 34, 36, 39, 42, 45, 54 |
| 24 AWG<br>0.2 mm <sup>2</sup>                           | 641438                            | 32, 33, 34, 36, 39, 42, 45, 54 | 641525                           | 32, 33, 34, 36, 39, 42, 45, 54 |
| 26 AWG<br>0.12-0.15 mm <sup>2</sup>                     | 641439                            | 32, 33, 34, 36, 39, 42, 45, 54 | 641526                           | 32, 33, 34, 36, 39, 42, 45, 54 |
| <b>Standard UL 94V-2, .000030 [0.00076] Gold Plated</b> |                                   |                                |                                  |                                |
| 18 AWG<br>0.8-0.9 mm <sup>2</sup>                       | 644807                            | 32, 33, 34, 36, 39, 42, 45, 54 | 644812                           | 32, 33, 34, 36, 39, 42, 45, 54 |
| 20 AWG<br>0.5-0.6 mm <sup>2</sup>                       | — <sup>2</sup>                    | —                              | — <sup>2</sup>                   | —                              |
| 22 AWG<br>0.3-0.4 mm <sup>2</sup>                       | 644809                            | 32, 33, 34, 36, 39, 42, 45, 54 | 644814                           | 32, 33, 34, 36, 39, 42, 45, 54 |
| 24 AWG<br>0.2 mm <sup>2</sup>                           | — <sup>2</sup>                    | —                              | — <sup>2</sup>                   | —                              |
| 26 AWG<br>0.12-0.15 mm <sup>2</sup>                     | — <sup>2</sup>                    | —                              | — <sup>2</sup>                   | —                              |
| <b>Standard UL 94V-2, .000015 [0.00038] Gold Plated</b> |                                   |                                |                                  |                                |
| 18 AWG<br>0.8-0.9 mm <sup>2</sup>                       | 647476                            | 32, 33, 34, 36, 39, 42, 45, 54 | 647481                           | 32, 33, 34, 36, 39, 42, 45, 54 |
| 22 AWG<br>0.3-0.4 mm <sup>2</sup>                       | 643995                            | 32, 33, 34, 36, 39, 42, 45, 54 | 647497                           | 32, 33, 34, 36, 39, 42, 45, 54 |

<sup>1</sup> MTA-156 Posted Connectors (Closed End and Feed-Thru) will **Only mate** with MTA-156 connectors with locking ramp and without polarizing tabs. They will **NOT mate** with MTA-156 Quad Connectors.

<sup>2</sup> Parts can be made available upon request. Minimums may apply.

| No. of Circuits | Dim.           |               | Suffix | No. of Circuits | Dim.           |                | Prefix/Suffix |
|-----------------|----------------|---------------|--------|-----------------|----------------|----------------|---------------|
|                 | A              | B             |        |                 | A              | B              |               |
| 2               | .468<br>11.89  | .316<br>8.03  | -2     | 9               | 1.560<br>39.62 | 1.408<br>35.76 | -9            |
| 3               | .624<br>15.85  | .472<br>11.99 | -3     | 12              | 2.028<br>51.51 | 1.876<br>47.65 | 1- -2         |
| 4               | .780<br>19.81  | .628<br>15.95 | -4     | 15              | 2.496<br>63.40 | 2.344<br>59.54 | 1- -5         |
| 6               | 1.092<br>27.74 | .940<br>23.88 | -6     | 24              | 3.900<br>99.06 | 3.748<br>95.20 | 2- -4         |

**Technical Documents**

**Product Specification**  
108-1065 MTA-156 Posted Connector

**Application Specification**  
114-1020 MTA-156 Connectors, Posted Connectors and Card Edge Connectors

**Replacement IDC Contacts**

**Material and Finish**

**Contacts** — Copper alloy, post tin plated over nickel



| AWG | Wire Size       |  | Part Numbers |
|-----|-----------------|--|--------------|
|     | mm <sup>2</sup> |  |              |
| 18  | 0.8-0.9         |  | 3-641425-1   |
| 20  | 0.5-0.6         |  | 3-641426-1   |
| 22  | 0.3-0.4         |  | 3-641427-1   |
| 24  | 0.2             |  | 3-641428-1   |
| 26  | 0.12-0.15       |  | 3-641429-1   |

## MTA-156 Flat Headers—Straight

### Material and Finish

**Housing**—UL94V-0 rated, polyester, white

**Posts**—Copper alloy, tin plated, .000030 [0.00076] or .000015 [0.00038] gold over nickel

**Notes:**

1. Post(s) can be omitted for keying purposes. Specify the desired post(s) to be omitted using the figure to identify Post No. 1.
2. Gold headers are duplex plated, gold on mating end of post and tin on the solder tail.
3. .125 [3.18] solder tail lengths are for .062 [1.57] thick printed circuit boards and .175 [4.45] solder tail lengths are for .093-.125 [2.36-3.18] thick printed circuit boards.
4. To determine header overall length (Dim. A), multiply .156 x the number of posts. Example: .156 x 10 posts equals 1.560 inches [39.62 mm].

For mateability options, see matrix on pages 34, 35, 54 and 58.

For mating half visuals, see pages 36 thru 39, 55, 60 and 62.



Recommended Mounting Hole Pattern for .062 [1.57] Thk. PC Board

| PC Board Hole Diameters |                       |
|-------------------------|-----------------------|
| Square Post             | Round Post            |
| .080/.070 [2.03/1.78]   | .070/.060 [1.78/1.52] |

### Header Ordering Information

The "Base Part Numbers" Chart at right shows the base part number and number of posts available for the described headers.

Prefixes and suffixes are determined by the number of post positions in the header. For example, the complete part number for a 10-position header with square posts and a .125 [3.18] solder tail length would be:

Base number **640383** plus prefix-and-suffix **4- -0**

The correct ordering number is **4-640383-0**

The part numbers in **bold face** are the RoHS equivalent version. Example:

| No. of Pos. | Lead Free RoHS Prefix/Suffix |
|-------------|------------------------------|
| 2           | 3-640383-2                   |
|             | thru                         |
| 24          | 5-640383-4                   |

See page 15 for an explanation of RoHS lead free equivalents.

**Note:** All RoHS equivalent part numbers may not be available upon catalog release. If the number you need is not available, please contact Product Engineering to expedite your request.

### Base Part Numbers

| Square Posts   |             |                         |             | Round Posts             |             |                         |             |
|--|-------------|-------------------------|-------------|-------------------------|-------------|-------------------------|-------------|
| .125 [3.18] Solder tail                                |             | .175 [4.45] Solder tail |             | .125 [3.18] Solder tail |             | .175 [4.45] Solder tail |             |
| Header Part Nos.                                       | RoHS Equiv. | Header Part Nos.        | RoHS Equiv. | Header Part Nos.        | RoHS Equiv. | Header Part Nos.        | RoHS Equiv. |
| <b>Standard UL94V-0, Tin Plated</b>                    |             |                         |             |                         |             |                         |             |
| 640383   | 2-24        | 644749                  | 2-24        | 640384                  | 2-24        | 644750                  | 2-24        |
| <b>Standard UL94V-0, .000030 [0.00076] Gold Plated</b> |             |                         |             |                         |             |                         |             |
| 641202   | 32-54       | 644756                  | 32-54       | 641203                  | 32-54       | 644757                  | 32-54       |
| <b>Standard UL94V-0, .000015 [0.00038] Gold Plated</b> |             |                         |             |                         |             |                         |             |
| 641113   | 32-54       | 644763                  | 32-54       | 641114                  | 32-54       | 644764                  | 32-54       |

**Note:** Consult Product Drawing for details on placing headers onto PC boards.

**Note:**

Select load headers (omitted pin headers) are available upon request. Please contact product engineer or product manager for details.

MTA-156  
.156 [3.96]



**MTA-156 Flat Headers—Right-Angle**

**Material and Finish**

**Housing**—UL94V-0 rated, polyester, white

**Posts**—Copper alloy, tin plated, .000030 [0.00076] or .000015 [0.00038] gold over nickel

**Notes:**

1. Post(s) can be omitted for keying purposes. Specify the desired post(s) to be omitted using the figure to identify Post No. 1.
2. Gold headers are duplex plated, gold on mating end of post and tin on the solder tail.
3. .125 [3.18] solder tail lengths are for .062 [1.57] thick printed circuit boards and .175 [4.45] solder tail lengths are for .093-.125 [2.36-3.18] thick printed circuit boards.
4. To determine header overall length (Dim. A), multiply .156 x the number of posts. Example: .156 x 10 posts equals 1.560 inches [39.62 mm].

For mateability options, see matrix on pages 34, 35, 54 and 58.

For mating half visuals, see pages 36 thru 39, 55, 60 and 62.

**Header Ordering Information**

The "Base Part Numbers" Chart at right shows the base part number and number of posts available for the described headers.

Prefixes and suffixes are determined by the number of post positions in the header. For example, the complete part number for a 10-position header with square posts and a .125 [3.18] solder tail length would be:

Base number **641204** plus prefix-and-suffix **4- -0**

The correct ordering number is **4-641204-0**

The part numbers in **bold face** are the RoHS equivalent version. Example:

| No. of Pos. | Lead Free RoHS Prefix/Suffix |
|-------------|------------------------------|
| 2           | 3-641204-2                   |
|             | thru                         |
| 24          | 5-641204-4                   |

See page 15 for an explanation of RoHS lead free equivalents.

**Note:** All RoHS equivalent part numbers may not be available upon catalog release. If the number you need is not available, please contact Product Engineering to expedite your request.



**Recommended Mounting Hole Pattern for .062 [1.57] Thk. PC Board**

X = .140 [3.56] Min., .430 [10.92] Max. when mated with MTA Connector.  
 X = .140 [3.56] Min. when mated with SL-156 Wire-to-Board Connector.

**Note:** Consult Product Drawing for details on placing headers onto PC boards.



**Recommended Mounting Hole Pattern for .063 [1.60] Thk. PC Board for Retentive Leg Header**  
 Y = .140 [3.56] Min., .430 [10.92] Max. when mated with MTA Connector.

**Base Part Numbers**

| Retentive Leg  |             | Square Posts            |             | Retentive Leg           |             |
|--|-------------|-------------------------|-------------|-------------------------|-------------|
|  |             | .125 [3.18] Solder tail |             | .175 [4.45] Solder tail |             |
| Header Part Nos.                                       | RoHS Equiv. | Header Part Nos.        | RoHS Equiv. | Header Part Nos.        | RoHS Equiv. |
| <b>Standard UL94V-0, Tin Plated</b>                    |             |                         |             |                         |             |
| 647646   | 2-12        | 640385                  | 2-24        | 644751                  | 2-24        |
| <b>Standard UL94V-0, .000030 [0.00076] Gold Plated</b> |             |                         |             |                         |             |
| —  | —           | 641204                  | 32-54       | 644758                  | 32-54       |
| <b>Standard UL94V-0, .000015 [0.00038] Gold Plated</b> |             |                         |             |                         |             |
| —  | —           | 641115                  | 32-54       | 644765                  | 32-54       |

**Note:** Select load headers (omitted pin headers) are available upon request. Please contact product engineer or product manager for details.

## MTA-156 Friction Lock Headers—Straight

### Material and Finish

**Housing**—UL94V-0 rated, polyester, white

**Posts**—Copper alloy, tin plated, .000030 [0.00076] or .000015 [0.00038] gold over nickel

**Notes:**

1. Post(s) can be omitted for keying purposes. Specify the desired post(s) to be omitted using the figure to identify Post No. 1.
2. Gold headers are duplex plated, gold on mating end of post and tin on the solder tail.
3. .125 [3.18] solder tail lengths are for .062 [1.57] thick printed circuit boards and .175 [4.45] solder tail lengths are for .093-.125 [2.36-3.18] thick printed circuit boards.
4. To determine header overall length (Dim. A), multiply .156 x the number of posts. Example: .156 x 10 posts equals 1.560 inches [39.62 mm].

For mateability options, see matrix on pages 34, 35, 54 and 58.

For mating half visuals, use connectors with a locking ramp for polarization/retention purposes, see pages 36 thru 39, 55, 60 and 62.

For polarizing purposes only use connectors without a locking ramp. See pages 36 thru 39, 55, 60 and 62.

### Header Ordering Information

The "Base Part Numbers" Chart at right shows the base part number and number of posts available for the described headers.

Prefixes and suffixes are determined by the number of post positions in the header. For example, the complete part number for a 10-position header with square posts and a .125 [3.18] solder tail length would be: Base number **641208** plus prefix-and-suffix **4- -0**

The correct ordering number is **4-641208-0**

The part numbers in **bold face** are the RoHS equivalent version. Example:

| No. of Pos. | Standard Prefix/Suffix | Lead Free RoHS Prefix/Suffix |
|-------------|------------------------|------------------------------|
| 2           | 641208-2               | 3-641208-2                   |
|             | thru                   |                              |
| 24          | 2-641208-4             | 5-641208-4                   |

See page 15 for an explanation of RoHS lead free equivalents.



Y = .068 [1.73] Max. 2-8 position tin plated and 2-24 position gold plated headers.

Y = .073 [1.85] 9-24 position tin plated headers.



Recommended Mounting Hole Pattern for .062 [1.57] Thk. PC Board

| PC Board Hole Diameters |                       |
|-------------------------|-----------------------|
| Square Post             | Round Post            |
| .080/.070 [2.03/1.78]   | .070/.060 [1.78/1.52] |



Note: Consult Product Drawing for details on placing headers onto PC boards.

### Base Part Numbers

|  |             | Square Posts            |             |                         |             | Round Posts             |             |                         |             |
|--|-------------|-------------------------|-------------|-------------------------|-------------|-------------------------|-------------|-------------------------|-------------|
|  |             | .125 [3.18] Solder tail |             | .175 [4.45] Solder tail |             | .125 [3.18] Solder tail |             | .175 [4.45] Solder tail |             |
| Header Part Nos.                                       | RoHS Equiv. | Header Part Nos.        | RoHS Equiv. | Header Part Nos.        | RoHS Equiv. | Header Part Nos.        | RoHS Equiv. | Header Part Nos.        | RoHS Equiv. |
| <b>Standard UL94V-0, Tin Plated</b>                    |             |                         |             |                         |             |                         |             |                         |             |
| 1744017  | 2-12        | 640445                  | 2-24        | 644752                  | 2-24        | 640388                  | 2-24        | 644753                  | 2-24        |
| <b>Standard UL94V-0, .000030 [0.00076] Gold Plated</b> |             |                         |             |                         |             |                         |             |                         |             |
| —  | —           | 641208                  | 32-54       | 644759                  | 32-54       | 641209                  | 32-54       | 644760                  | 32-54       |
| <b>Standard UL94V-0, .000015 [0.00038] Gold Plated</b> |             |                         |             |                         |             |                         |             |                         |             |
| —  | —           | 641119                  | 32-54       | 644766                  | 32-54       | 641120                  | 32-54       | 644767                  | 32-54       |

Note: All RoHS equivalent part numbers may not be available upon catalog release. If the number you need is not available, please contact Product Engineering to expedite your request.

**Note:**

Select load headers (omitted pin headers) and tube loaded product are available upon request. Please contact product engineer or product manager for details.

MTA-156 .156 [3.96]

## MTA-156 Friction Lock Headers—Right-Angle

### Material and Finish

**Housing** — UL94V-0 rated, polyester, white

**Posts** — Copper alloy, tin plated, .000030 [0.00076] or .000015 [0.00038] gold over nickel

**Notes:**

1. Post(s) can be omitted for keying purposes. Specify the desired post(s) to be omitted using the figure to identify Post No. 1.
2. Gold headers are duplex plated, gold on mating end of post and tin on the solder tail.
3. .125 [3.18] solder tail lengths are for .062 [1.57] thick printed circuit boards and .175 [4.45] solder tail lengths are for .093-.125 [2.36-3.18] thick printed circuit boards.
4. To determine header overall length (Dim. A), multiply .156 x the number of posts. Example: .156 x 10 posts equals 1.560 inches [39.62 mm].

For mateability options, see matrix on pages 34, 35, 54 and 58.

When using Front Bend Headers—for mating half visuals use connectors with a locking ramp for polarization/retention purposes. When using Rear Bend Headers—for mating half visuals use connectors without a locking ramp. For polarization purposes only see pages 36 thru 39, 55, 60 and 62.



Recommended Mounting Hole Pattern for .062 [1.57] Thk. PC Board

Y = .068 [1.73] Max. 2-8 position tin plated and 2-24 position gold plated headers.

Y = .073 [1.85] 9-24 position tin plated headers.



**Front Bend**  
 X = .325 [8.26] Min., .400 [10.16] Max., when mated with MTA Connector.  
 X = .325 [8.26] Min., .345 [8.76] Max., when mated with SL-156 Connector.

**Rear Bend**  
 X = .500 [12.7] Min., .650 [16.51] Max., when mated with MTA Connector.  
 X = .500 [12.7] Min., when mated with SL-156 Connector.

### Header Ordering Information

The "Base Part Numbers" Chart at right shows the base part number and number of posts available for the described headers.

Prefixes and suffixes are determined by the number of post positions in the header. For example, the complete part number for a 10-position header with square posts, front bend, and a .125 [3.18] solder tail length would be:

Base number **641210** plus prefix-and-suffix **4- -0**

The correct ordering number is **4-641210-0**

The part numbers in **bold face** are the RoHS equivalent version. Example:

| No. of Pos. | Standard Prefix/Suffix | Lead Free RoHS Prefix/Suffix |
|-------------|------------------------|------------------------------|
| 2           | 641210-2               | 3-641210-2                   |
| thru        |                        |                              |
| 24          | 2-641210-4             | 5-641210-4                   |

See page 15 for an explanation of RoHS lead free equivalents.

Note: Consult Product Drawing for details on placing headers onto PC boards.

### Base Part Numbers

| Square Posts   |             |                         |             |                         |             |                         |             |
|--|-------------|-------------------------|-------------|-------------------------|-------------|-------------------------|-------------|
| Front Bend   |             |                         |             | Rear Bend               |             |                         |             |
| .125 [3.18] Solder tail                                |             | .175 [4.45] Solder tail |             | .125 [3.18] Solder tail |             | .175 [4.45] Solder tail |             |
| Header Part Nos.                                       | RoHS Equiv. | Header Part Nos.        | RoHS Equiv. | Header Part Nos.        | RoHS Equiv. | Header Part Nos.        | RoHS Equiv. |
| <b>Standard UL94V-0, Tin Plated</b>                    |             |                         |             |                         |             |                         |             |
| 640389   | 2-24        | 644754                  | 2-24        | 640387                  | 2-24        | 644755                  | 2-24        |
| <b>Standard UL94V-0, .000030 [0.00076] Gold Plated</b> |             |                         |             |                         |             |                         |             |
| 641210   | 32-54       | 644761                  | 32-54       | 641207                  | 32-54       | 644762                  | 32-54       |
| <b>Standard UL94V-0, .000015 [0.00038] Gold Plated</b> |             |                         |             |                         |             |                         |             |
| 641121   | 32-54       | 644768                  | 32-54       | 641118                  | 32-54       | 644769                  | 32-54       |

Note: All RoHS equivalent part numbers may not be available upon catalog release. If the number you need is not available, please contact Product Engineering to expedite your request.

Note: Select lead headers (omitted pin headers) are available upon request. Please contact product engineer or product manager for details.

**MTA-156 Polarized Lock Headers—Straight**

**Material and Finish**

**Housing** — UL94V-0 rated, polyester, white

**Posts** — Copper alloy, tin plated or .000030 [0.00076] gold over nickel

**Notes:**

1. Post(s) can be omitted for keying purposes. Specify the desired post(s) to be omitted using the figure to identify Post No. 1.
2. Peg holes are not required in PC Boards when headers without pegs are used.
3. One peg only on a 2 position header, other position sizes have two pegs.
4. Headers with .00015 [0.00038] gold plated post are available upon request. Minimums may apply.
5. To determine header overall length (Dim. A), multiply .156 x the number of posts. Example: .156 x 10 posts equals 1.560 inches [39.62 mm].

For mateability options, see matrix on pages 34, 35, 54 and 58.

For mating half visuals, use connectors with a locking ramp for polarization/retention purposes, see pages 36 thru 39, 55, 60 and 62.

For polarizing purposes only use connectors without a locking ramp. See pages 36 thru 39, 60 and 62.

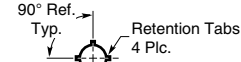

**Polarized Retention Peg**

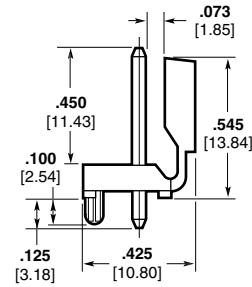

| PC Board Hole Diameters  |                          |
|--------------------------|--------------------------|
| Square Post              | Round Post               |
| .069/.065<br>[1.75/1.65] | .054/.050<br>[1.37/1.27] |

**Recommended Mounting Hole Pattern for .062 [1.57] Thk. PC Board**

**Note:** Consult Product Drawing for details on placing headers onto PC boards.

**Header Ordering Information**

The "Base Part Numbers" Chart at right shows the base part number and number of posts available for the described headers.

Prefixes and suffixes are determined by the number of post positions in the header. For example, the complete part number for a 10-position header with square posts with pegs would be:

Base number **644615** plus prefix-and-suffix **4- -0**

The correct ordering number is **4-644615-0**

The part numbers in **bold face** are the RoHS equivalent version. Example:

| No. of Pos. | Lead Free RoHS Prefix/Suffix |
|-------------|------------------------------|
| 2           | 3-644615-2                   |
|             | thru                         |
| 18          | 4-644615-8                   |

See page 15 for an explanation of RoHS lead free equivalents.

**Base Part Numbers**

| Square Posts   |              |                  |              | Round Posts      |              |                  |              |
|--|--------------|------------------|--------------|------------------|--------------|------------------|--------------|
| Without Pegs   |              | With Pegs        |              | Without Pegs     |              | With Pegs        |              |
| Header Part Nos.                                       | RoHS Equiv.  | Header Part Nos. | RoHS Equiv.  | Header Part Nos. | RoHS Equiv.  | Header Part Nos. | RoHS Equiv.  |
| <b>Standard UL94V-0, Tin Plated</b>                    |              |                  |              |                  |              |                  |              |
| 644611   | <b>32-48</b> | 644615           | <b>32-48</b> | 644612           | <b>32-48</b> | 644616           | <b>32-48</b> |
| <b>Standard UL94V-0, .000030 [0.00076] Gold Plated</b> |              |                  |              |                  |              |                  |              |
| 644627   | <b>32-48</b> | 644631           | <b>32-48</b> | 644628           | <b>32-48</b> | 644632           | <b>32-48</b> |

**Note:** All RoHS equivalent part numbers may not be available upon catalog release. If the number you need is not available, please contact Product Engineering to expedite your request.

**Note:** Select load headers (omitted pin headers) are available upon request. Please contact product engineer or product manager for details.

MTA-156 .156 [3.96]

**MTA-156 Polarized Lock Headers—Right-Angle**

**Material and Finish**

**Housing**—UL94V-0 rated, polyester, white

**Posts**—Copper alloy, tin plated or .000030 [0.00076] gold over nickel

**Notes:**

1. Post(s) can be omitted for keying purposes. Specify the desired post(s) to be omitted using the figure to identify Post No. 1.
2. Peg holes are not required in PC Boards when headers without pegs are used.
3. One peg only on a 2 position header, other position sizes have two pegs.
4. Headers with .00015 [0.00038] gold plated post are available upon request. Minimums may apply.
5. To determine header overall length (Dim. A), multiply .156 x the number of posts. Example: .156 x 10 posts equals 1.560 inches [39.62 mm].

For mateability options, see matrix on pages 34, 35, 54 and 58.

For mating half visuals, use only connectors with a locking ramp for polarization/retention purposes, see pages 36 thru 39, 55, 60 and 62.

For polarizing purposes only use connectors without a locking ramp. See pages 36 thru 39, 60 and 62.

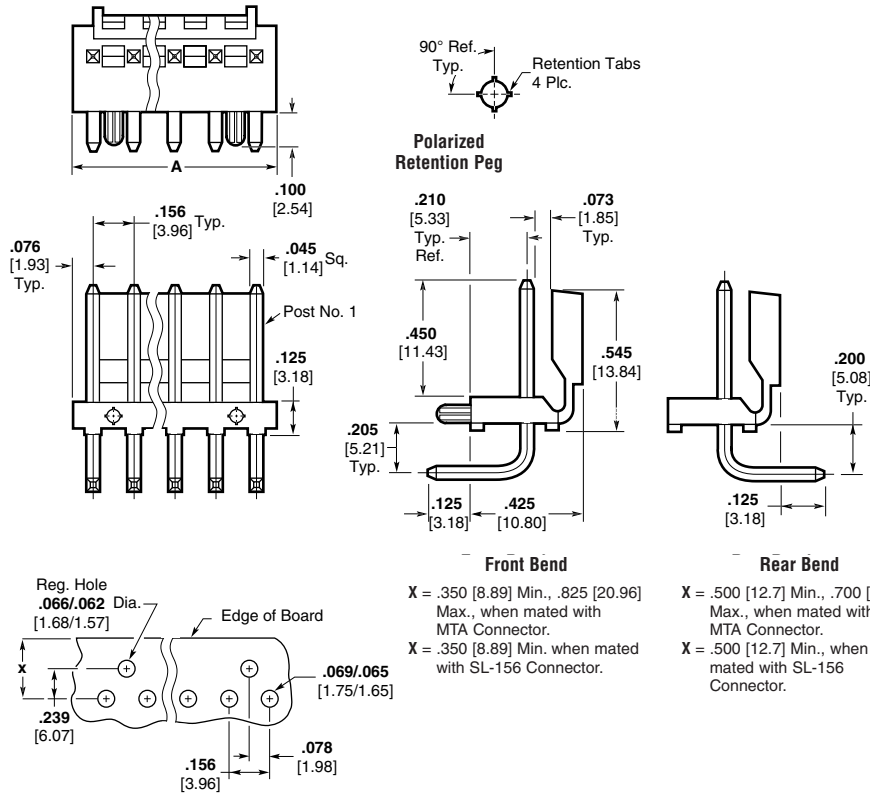

**Recommended Mounting Hole Pattern for .062 [1.57] Thk. PC Board**

**Note:** Consult Product Drawing for details on placing headers onto PC boards.

**Header Ordering Information**

The “Base Part Numbers” Chart at right shows the base part number and number of posts available for the described headers.

Prefixes and suffixes are determined by the number of post positions in the header. For example, the complete part number for a 10-position header with front bend and with pegs would be:

Base number **644617** plus prefix-and-suffix **4- -0**

The correct ordering number is **4-644617-0**

The part numbers in **bold face** are the RoHS equivalent version. Example:

| No. of Pos. | Lead Free RoHS Prefix/Suffix |
|-------------|------------------------------|
| 2           | <b>3-644617-2</b>            |
|             | thru                         |
| 18          | <b>4-644617-8</b>            |

See page 15 for an explanation of RoHS lead free equivalents.

**Base Part Numbers**

| Square Posts   |              |                  |              |                  |              |
|--|--------------|------------------|--------------|------------------|--------------|
| Front Bend   |              |                  |              | Rear Bend        |              |
| Without Pegs   |              | With Pegs        |              | Without Pegs     |              |
| Header Part Nos.                                       | RoHS Equiv.  | Header Part Nos. | RoHS Equiv.  | Header Part Nos. | RoHS Equiv.  |
| <b>Standard UL94V-0, Tin Plated</b>                    |              |                  |              |                  |              |
| 644613   | <b>32-48</b> | 644617           | <b>32-48</b> | 644614           | <b>32-48</b> |
| <b>Standard UL94V-0, .000030 [0.00076] Gold Plated</b> |              |                  |              |                  |              |
| 644629   | <b>32-48</b> | 644633           | <b>32-48</b> | 644630           | <b>32-48</b> |

**Note:** All RoHS equivalent part numbers may not be available upon catalog release. If the number you need is not available, please contact Product Engineering to expedite your request.

**Note:** Select load headers (omitted pin headers) are available upon request. Please contact product engineer or product manager for details.

**MTA-156 Friction Lock High Temperature Headers—Straight**

**Material and Finish**

**Housing** — UL94V-0 rated, nylon, black

**Posts** — Copper alloy, tin plated, .000015 [0.00038] gold over nickel

**Temperature** — Maximum Temperature Rating: 280°C

**Notes:**

1. Post(s) can be omitted for keying purposes. Specify the desired post(s) to be omitted using the figure to identify Post No. 1.
2. Gold headers are duplex plated, gold on mating end of post and tin-lead on the solder tail.
3. Headers with straight and right-angle square posts are available upon request. Minimums may apply.
4. To determine header overall length (Dim. A), multiply .156 x the number of posts. Example: .156 x 10 posts equals 1.560 inches [39.62 mm].

For mateability options, see matrix on pages 34, 35, 54 and 58.

For mating half visuals, use connectors with a locking ramp for polarization/retention purposes, see pages 36 thru 39, 55, 60 and 62.

For polarizing purposes only use connectors without a locking ramp. See pages 36 thru 39, 60 and 62.

**Header Ordering Information**

The “Base Part Numbers” Chart at right shows the base part number and number of posts available for the described headers.

Prefixes and suffixes are determined by the number of post positions in the header. For example, the complete part number for a 10-position header with round tin plated posts:

Base number **647648** plus prefix-and-suffix **4- -0**

The correct ordering number is **4-647648-0**

The part numbers in **bold face** are the RoHS equivalent version. Example:

| No. of Pos. | Lead Free RoHS Prefix/Suffix |
|-------------|------------------------------|
| 2           | 3-647648-2                   |
| 12          | 4-647648-2                   |

See page 15 for an explanation of RoHS lead free equivalents.

**Note:** All RoHS equivalent part numbers may not be available upon catalog release. If the number you need is not available, please contact Product Engineering to expedite your request.

**For use with Infrared Reflow Process**



**Recommended Mounting Hole Pattern for .062 [1.57] Thick PC Board**

**Note:** Consult Product Drawing for details on placing headers onto PC boards.

**Base Part Numbers**

| Round Post   |              |
|--|--------------|
| Header Part Nos.                                       | RoHS Equiv.  |
| <b>Standard UL94V-0, Tin Plated</b>                    |              |
| 647648   | <b>32-42</b> |
| <b>Standard UL94V-0, .000015 [0.00038] Gold Plated</b> |              |
| 647649   | <b>32-42</b> |

**Note:**

Select load headers (omitted pin headers) are available upon request. Please contact product engineer or product manager for details.

MTA-156 .156 [3.96]



## MTA-156 Shrouded Headers—Straight and Right-Angle

### Material and Finish

**Housing**—UL94V-0 rated, polyester, black

**Posts**—Copper alloy, tin plated; or .000030 [0.00076] or .000015 [0.00038] gold over nickel

#### Notes:

1. Post(s) can be omitted for keying purposes. Specify the desired post(s) to be omitted using the figure to identify Post No. 1.
2. Gold headers are duplex plated, gold on mating end of post and tin on the solder tail.
3. Peg holes are not required in PC boards when headers without pegs are used.
4. One peg only on a 2 position header, other position sizes have two pegs.
5. Right-angle front and rear bend headers with retention pegs can be made available upon request. Minimums may apply.

For mateability options, see matrix on pages 34, 35, 54 and 58.

For mating half visuals, see pages 36 thru 39 and 55.

### Header Ordering Information

The “Base Part Numbers” Chart at right shows the base part number and number of posts available for the described headers.

Prefixes and suffixes are determined by the number of post positions in the header. For example, the complete part number for a 10-position header with straight, square posts and with pegs would be: Base number **647127** plus prefix-and-suffix **4- -0**

The correct ordering number is **4-647127-0**

| No. of Pos. | Dim. A         | RoHS Prefix/Suffix |
|-------------|----------------|--------------------|
| 2           | .406<br>10.31  | 2--2               |
| 3           | .562<br>14.27  | 2--3               |
| 4           | .718<br>18.24  | 2--4               |
| 5           | .874<br>22.20  | 2--5               |
| 6           | 1.030<br>26.16 | 2--6               |
| 7           | 1.186<br>30.12 | 2--7               |
| 8           | 1.342<br>34.09 | 2--8               |
| 9           | 1.498<br>38.05 | 2--9               |
| 10          | 1.654<br>42.01 | 3--0               |
| 11          | 1.810<br>45.97 | 3--1               |
| 12          | 1.966<br>49.94 | 3--2               |

**Note:** All RoHS equivalent part numbers may not be available upon catalog release. If the number you need is not available, please contact Product Engineering to expedite your request.

### Straight Post (.045 [1.14] Square or Round)

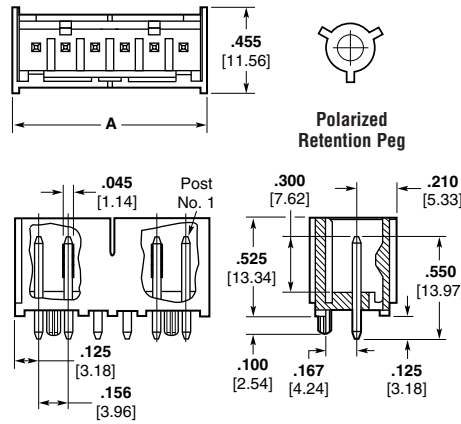

### Right-Angle (.045 [1.14] Square)

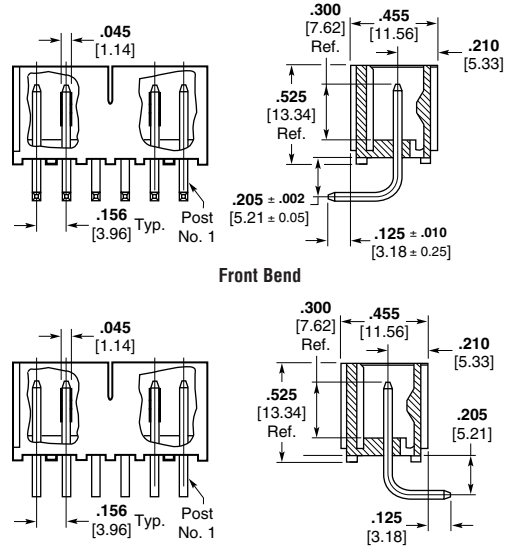

### PC Board Hole Diameters

| Square Post              | Round Post               |
|--------------------------|--------------------------|
| .069/.065<br>[1.75/1.65] | .054/.050<br>[1.37/1.27] |

**Note:** Consult Product Drawing for details on placing headers onto PC boards.



Recommended Mounting Hole Pattern for .062 [1.57] Thick PC Board Using a Straight Post Header

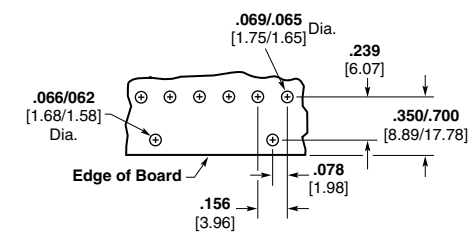

Recommended Mounting Hole Pattern for .062 [1.57] Thick PC Board Using a Right-Angle Header

### Base Part Numbers

| Straight Square Posts                                  |             |                  |             | Straight Round Posts                      |             |                  |             |
|--|-------------|------------------|-------------|---|-------------|------------------|-------------|
| Without Pegs   |             | With Pegs        |             | Without Pegs                              |             | With Pegs        |             |
| Header Part Nos.                                       | RoHS Equiv. | Header Part Nos. | RoHS Equiv. | Header Part Nos.                          | RoHS Equiv. | Header Part Nos. | RoHS Equiv. |
| <b>Standard UL94V-0, Tin Plated</b>                    |             |                  |             |   |             |                  |             |
| 647123   | 22-32       | 647127           | 22-32       | 647124                                    | 22-32       | 647128           | 22-32       |
| <b>Standard UL94V-0, .000030 [0.00076] Gold Plated</b> |             |                  |             |   |             |                  |             |
| 647131   | 22-32       | 647135           | 22-32       | 647132                                    | 22-32       | 647136           | 22-32       |
| <b>Standard UL94V-0, .000015 [0.00038] Gold Plated</b> |             |                  |             |   |             |                  |             |
| 647139   | 22-32       | 647143           | 22-32       | 647140                                    | 22-32       | 647144           | 22-32       |
| <b>Square Posts</b>                                    |             |                  |             |   |             |                  |             |
| Right-Angle Posts, Front Bend Without Pegs             |             |                  |             | Right-Angle Posts, Rear Bend Without Pegs |             |                  |             |
| Header Part Nos.                                       |             | RoHS Equiv.      |             | Header Part Nos.                          |             | RoHS Equiv.      |             |
| <b>Standard UL94V-0, Tin Plated</b>                    |             |                  |             |   |             |                  |             |
| 647125   |             | 22-32            |             | 647126                                    |             | 22-32            |             |
| <b>Standard UL94V-0, .000030 [0.00076] Gold Plated</b> |             |                  |             |   |             |                  |             |
| 647133   |             | 22-32            |             | 647134                                    |             | 22-32            |             |
| <b>Standard UL94V-0, .000015 [0.00038] Gold Plated</b> |             |                  |             |   |             |                  |             |
| 647141   |             | 22-32            |             | 647142                                    |             | 22-32            |             |

**Note:** Select load headers (omitted pin headers) are available upon request. Please contact product engineer or product manager for details.

**MTA-156 IDC Quad Connectors**

**Product Facts**

- Provides four points of contact
- Greater current carrying capability than Standard MTA-156 Connectors
- Connector styles include both closed end and feed-thru with locking ramp, with and without polarizing tabs in 2 through 12 positions
- Available for wire ranges of 18–22 AWG [0.9–0.3 mm<sup>2</sup>]
- Contacts are lubricated for fretting corrosion protection
- Complies with Tyco Electronics Quality Specification 102-6, “Preparation of Design Objectives”
- Uses existing MTA application tooling for termination
- Quad connectors preloaded with contacts
- All contacts are slotted for insulation displacement (IDC) termination technique
- Connectors and headers are end-to-end stackable
- AWG size is “frosted” on the side of the connector
- Recognized under the Component Program of Underwriters Laboratories Inc.,  File No. E28476
- Certified by Canadian Standards Association,  File No. LR 7189
- Satisfies the VDE requirements according to VDE 110, Insulation Group B, 250 vac for air and creepage paths

The MTA-156 Quad Connector provides a connection with four points of contact. The UL94V-0 rated connector with multi-point contacts provides greater current carrying capability than the Standard MTA-156 Connector. These connectors comply with Tyco Electronics Quality Specification 102-6\* and satisfy the VDE requirements according to VDE 110.

The connectors are available for wire ranges of 18–22 AWG [0.9–0.3 mm<sup>2</sup>] and in a variety of styles including closed end and feed-thru with locking ramp, with and without polarizing tabs.

Only one wire to be terminated into an IDC contact slot.

\*The 102-6 Quality Specification is the new procedure for “Preparation of Design Objectives”. Its purpose is to provide a means for verifying the maximum current carrying capacity of the device.

**Note:** Refer to pages 70 through 74 for approved wire listings.



**The MTA-156 Quad Connectors only mate with standard MTA-156 square post headers and use existing MTA application tooling for termination.**

**Performance Data**

- Voltage Rating** — 600 vac
- Current Rating** — 12.5 amp max. on a single circuit.
- For Multiple Circuit Loading** — refer to Product Specification for current rating chart.
- Low-Level Resistance** — 3.0 mΩ max. initial
- Dielectric Withstanding Voltage** — 1500 vac/1 min.
- Insulation Resistance** — 5000 MΩ min. initial
- Operating Temperature** — -55° C to +105° C

**Technical Documents**

**Product Specifications**

108-1219 MTA-156 Quad Connector System

**Application Specifications**

114-1048 MTA-156 Quad Connector

This matrix has been prepared to assist you, our customer, in defining the correct mating halves for the MTA-156 header and connector combination. Where a “Y” is indicated the combination is a valid mating pair.

**Headers**

|        | 640383 | 640385 | 640389 | 640445 | 644611 | 644613 | 644615 | 644617 | 644749 | 644751 | 644752 | 644754 | 647123 | 647125 | 647126 | 647127 |
|--------|--------|--------|--------|--------|--------|--------|--------|--------|--------|--------|--------|--------|--------|--------|--------|--------|
| 644329 | Y      | Y      | Y      | Y      | Y      | Y      | Y      | Y      | Y      | Y      | Y      | Y      | Y      | Y      | Y      | Y      |
| 644370 | Y      | Y      | Y      | Y      | Y      | Y      | Y      | Y      | Y      | Y      | Y      | Y      | Y      | Y      | Y      | Y      |
| 644371 | Y      | Y      | Y      | Y      | Y      | Y      | Y      | Y      | Y      | Y      | Y      | Y      | Y      | Y      | Y      | Y      |
| 644375 | Y      | Y      | Y      | Y      | Y      | Y      | Y      | Y      | Y      | Y      | Y      | Y      | Y      | Y      | Y      | Y      |
| 644376 | Y      | Y      | Y      | Y      | Y      | Y      | Y      | Y      | Y      | Y      | Y      | Y      | Y      | Y      | Y      | Y      |
| 644377 | Y      | Y      | Y      | Y      | Y      | Y      | Y      | Y      | Y      | Y      | Y      | Y      | Y      | Y      | Y      | Y      |
| 644381 | Y      | Y      | Y      | Y      | Y      | Y      | Y      | Y      | Y      | Y      | Y      | Y      | Y      | Y      | Y      | Y      |
| 644382 | Y      | Y      | Y      | Y      | Y      | Y      | Y      | Y      | Y      | Y      | Y      | Y      | Y      | Y      | Y      | Y      |
| 644383 | Y      | Y      | Y      | Y      | Y      | Y      | Y      | Y      | Y      | Y      | Y      | Y      | Y      | Y      | Y      | Y      |
| 644387 | Y      | Y      | Y      | Y      | Y      | Y      | Y      | Y      | Y      | Y      | Y      | Y      | Y      | Y      | Y      | Y      |
| 644388 | Y      | Y      | Y      | Y      | Y      | Y      | Y      | Y      | Y      | Y      | Y      | Y      | Y      | Y      | Y      | Y      |
| 644389 | Y      | Y      | Y      | Y      | Y      | Y      | Y      | Y      | Y      | Y      | Y      | Y      | Y      | Y      | Y      | Y      |

MTA-156 .156 [3.96]

## MTA-156 IDC Quad Connectors—Closed End and Feed-Thru

### Closed End with Locking Ramp

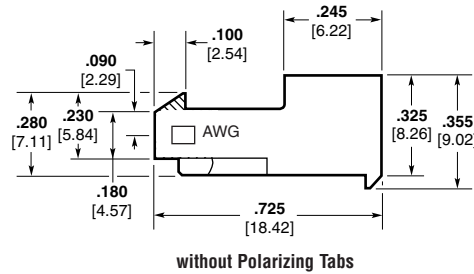
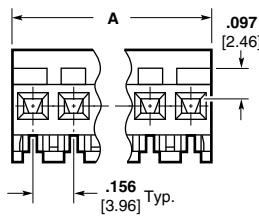

without Polarizing Tabs

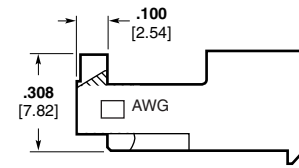

with Polarizing Tabs

### Feed-Thru with Locking Ramp

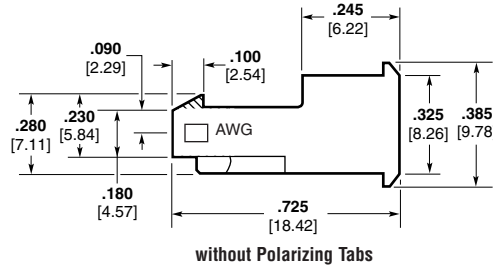
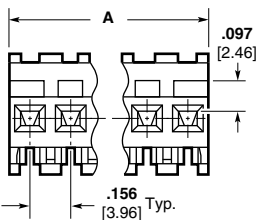

without Polarizing Tabs

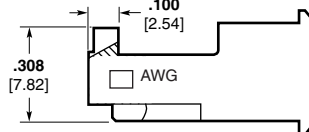

with Polarizing Tabs

### Material and Finish

**Housing**—UL94V-0 rated, nylon, black

**Contacts**—High conductivity copper alloy, post tin plated

For mateability options, see matrix on page 54.

For strain relief and dust covers, see pages 40 and 41.

For mating half visuals, see pages 46 thru 48 and 50, 52 and 53, (49 and 51 Front Bend Headers only). **Mates with tin-plated square posts only.**

Refer to pages 70 thru 74 for approved wire listing.

**Note:** To determine connector overall length (Dim. A), multiply .156 x the number of circuits. Example: .156 x 10 circuits equals 1.560 inches [39.62 mm].

### Base Part Numbers

| Connector Type & Wire Size               | Closed End with Locking Ramp |              |                     |              | Feed-Thru with Locking Ramp |              |                     |              |
|--|------------------------------|--------------|---------------------|--------------|-----------------------------|--------------|---------------------|--------------|
|  | Without Tabs                 |              | With Tabs           |              | Without Tabs                |              | With Tabs           |              |
|  | Connector Part Nos.          | RoHS Equiv.  | Connector Part Nos. | RoHS Equiv.  | Connector Part Nos.         | RoHS Equiv.  | Connector Part Nos. | RoHS Equiv.  |
| <b>Standard UL94V-0, Tin Plated</b>      |                              |              |                     |              |                             |              |                     |              |
| <b>18 AWG</b><br>0.8-0.9 mm <sup>2</sup> | 644329                       | <b>32-42</b> | 644381              | <b>32-42</b> | 644375                      | <b>32-42</b> | 644387              | <b>32-42</b> |
| <b>20 AWG</b><br>0.5-0.6 mm <sup>2</sup> | 644370                       | <b>32-42</b> | 644382              | <b>32-42</b> | 644376                      | <b>32-42</b> | 644388              | <b>32-42</b> |
| <b>22 AWG</b><br>0.3-0.4 mm <sup>2</sup> | 644371                       | <b>32-42</b> | 644383              | <b>32-42</b> | 644377                      | <b>32-42</b> | 644389              | <b>32-42</b> |

### Connector Ordering Information

The "Base Part Numbers" Chart above shows the base part number and number of circuits available for the described connectors.

Prefixes and suffixes are determined by the number of circuit positions in the connector. For example, the complete part number for a 10-position closed end connector with locking ramp and without polarizing tabs for 18 AWG wire would be:

Base number **644329** plus  
prefix-and-suffix  
**1- -0**

The correct ordering number is  
**1-644329-0**

The set of numbers in **bold face** are the RoHS equivalent version of the standard product. Example:

| No. of Pos. | Standard Prefix/Suffix | Lead Free RoHS Prefix/Suffix |
|-------------|------------------------|------------------------------|
| 2           | 644329-2               | <b>3-644329-2</b>            |
| thru        |                        |                              |
| 12          | 1-644329-2             | <b>4-644329-2</b>            |

See page 15 for an explanation of RoHS lead free equivalents.

**Note:** All RoHS equivalent part numbers may not be available upon catalog release. If the number you need is not available, please contact Product Engineering to expedite your request.

### Replacement IDC Contacts

#### Material and Finish

**Contacts**—High conductivity copper alloy post tin plated

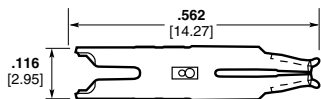

| Wire Size |                 | Part Numbers |
|-----------|-----------------|--------------|
| AWG       | mm <sup>2</sup> |              |
| 18        | 0.8-0.9         | 3-644508-1   |
| 20        | 0.5-0.6         | 3-644509-1   |
| 22        | 0.3-0.4         | 3-644510-1   |

**Note:** Tyco Electronics does not recommend terminating an MTA contact more than one time. Use replacement contacts when required for field repairs or wire gage changes.

MTA-156  
.156 [3.96]

**MTA-156 IDC Card Edge Connectors—Closed End and Feed-Thru**

**Material and Finish**

**Housing**—UL94V-0 rated, polyester, see chart for color

**Contacts**—Phosphor bronze, post tin plated

**Note:** Refer to pages 70 thru 74 for approved wire listings.

**Color Coding by Wire Size for UL94V-0 Connectors**

- 26 AWG — Blue
- 24 AWG — White
- 22 AWG — Red
- 20 AWG — Yellow
- 18 AWG — Orange

**Connector Ordering Information**

The “Base Part Numbers” Chart at right shows the base part number and number of circuits available for the described connectors.

Prefixes and suffixes are determined by the number of circuit positions in the connector. For example, the complete part number for a 12-position closed end connector without mounting ears for 18 AWG wire would be:

Base number **640859** plus prefix-and-suffix **1- -2**

The correct ordering number is **1-640859-2**

See page 15 for an explanation of RoHS lead free equivalents.

**Performance Data**

**Voltage Rating**—600 vac

**Current Rating**—5 amp max.

**Low-Level Resistance**—7 mΩ max. initial

**Dielectric Withstanding Voltage**—1250 vac/1 min.

**Insulation Resistance**—5000 MΩ min. initial

**Operating Temperature**—-55° C to +105° C

**Technical Documents**

**Product Specification**  
108-1058 MTA-156 Card Edge Connectors

**Application Specification**  
114-1020 MTA-156 Connectors, Posted Connectors and Card Edge Connectors



**Base Part Numbers**

| Connector Type & Wire Size          | Closed End            |   |                     |   | Feed-Thru             |   |                     |   |
|-------------------------------------|-----------------------|---|---------------------|---|-----------------------|---|---------------------|---|
|                                     | Without Mounting Ears |   | With Mounting Ears  |   | Without Mounting Ears |   | With Mounting Ears  |   |
|                                     | Connector Part Nos.   | No. of Circuits/RoHS Equiv.                                       | Connector Part Nos. | No. of Circuits/RoHS Equiv.                                       | Connector Part Nos.   | No. of Circuits/RoHS Equiv.                                       | Connector Part Nos. | No. of Circuits/RoHS Equiv.                                       |
| <b>Standard UL94V-0, Tin Plated</b> |                       |   |                     |   |                       |   |                     |   |
| 18 AWG<br>0.8-0.9 mm <sup>2</sup>   | 640859                | 3, 6, 9, 12,<br>15, 18, 20-24<br>33, 36, 39, 42,<br>45, 48, 50-54 | 640864              | 3, 6, 9, 12,<br>15, 18, 20-24<br>33, 36, 39, 42,<br>45, 48, 50-54 | 641283                | 3, 6, 9, 12,<br>15, 18, 20-24<br>33, 36, 39, 42,<br>45, 48, 50-54 | 641288              | 3, 6, 9, 12,<br>15, 18, 20-24<br>33, 36, 39, 42,<br>45, 48, 50-54 |
| 20 AWG<br>0.5-0.6 mm <sup>2</sup>   | 640860                | 3, 6, 9, 12,<br>15, 18, 20-24<br>33, 36, 39, 42,<br>45, 48, 50-54 | 640865              | 3, 6, 9, 12,<br>15, 18, 20-24<br>33, 36, 39, 42,<br>45, 48, 50-54 | 641284                | 3, 6, 9, 12,<br>15, 18, 20-24<br>33, 36, 39, 42,<br>45, 48, 50-54 | 641289              | 3, 6, 9, 12,<br>15, 18, 20-24<br>33, 36, 39, 42,<br>45, 48, 50-54 |
| 22 AWG<br>0.3-0.4 mm <sup>2</sup>   | 640861                | 3, 6, 9, 12,<br>15, 18, 20-24<br>33, 36, 39, 42,<br>45, 48, 50-54 | 640866              | 3, 6, 9, 12,<br>15, 18, 20-24<br>33, 36, 39, 42,<br>45, 48, 50-54 | 641285                | 3, 6, 9, 12,<br>15, 18, 20-24<br>33, 36, 39, 42,<br>45, 48, 50-54 | 641290              | 3, 6, 9, 12,<br>15, 18, 20-24<br>33, 36, 39, 42,<br>45, 48, 50-54 |
| 24 AWG<br>0.2 mm <sup>2</sup>       | 640862                | 3, 6, 9, 12,<br>15, 18, 20-24<br>33, 36, 39, 42,<br>45, 48, 50-54 | 640867              | 3, 6, 9, 12,<br>15, 18, 20-24<br>33, 36, 39, 42,<br>45, 48, 50-54 | 641286                | 3, 6, 9, 12,<br>15, 18, 20-24<br>33, 36, 39, 42,<br>45, 48, 50-54 | 641291              | 3, 6, 9, 12,<br>15, 18, 20-24<br>33, 36, 39, 42,<br>45, 48, 50-54 |
| 26 AWG<br>0.12-0.15 mm <sup>2</sup> | 640863                | 3, 6, 9, 12,<br>15, 18, 20-24<br>33, 36, 39, 42,<br>45, 48, 50-54 | 640868              | 3, 6, 9, 12,<br>15, 18, 20-24<br>33, 36, 39, 42,<br>45, 48, 50-54 | 641287                | 3, 6, 9, 12,<br>15, 18, 20-24<br>33, 36, 39, 42,<br>45, 48, 50-54 | 641292              | 3, 6, 9, 12,<br>15, 18, 20-24<br>33, 36, 39, 42,<br>45, 48, 50-54 |

| No. of Circuits | Dimensions    |                |                |               |               | Prefix/Suffix |
|-----------------|---------------|----------------|----------------|---------------|---------------|---------------|
|                 | A             | B              | C              | D             | E             |               |
| 3               | .500 [12.70]  | .926 [23.52]   | 1.248 [31.70]  | .484 [12.29]  | .650 [16.51]  | -3            |
| 6               | .968 [24.59]  | 1.394 [35.41]  | 1.716 [43.59]  | .952 [24.18]  | 1.118 [28.40] | -6            |
| 9               | 1.436 [36.47] | 1.862 [47.29]  | 2.184 [55.47]  | 1.420 [36.07] | 1.586 [40.28] | -9            |
| 12              | 1.904 [48.36] | 2.330 [59.18]  | 2.652 [67.36]  | 1.888 [47.96] | 2.054 [52.17] | 1- -2         |
| 15              | 2.372 [60.25] | 2.798 [71.07]  | 3.120 [79.25]  | 2.356 [59.84] | 2.522 [64.06] | 1- -5         |
| 18              | 2.840 [72.14] | 3.266 [82.96]  | 3.588 [91.14]  | 2.824 [71.73] | 2.990 [75.95] | 1- -8         |
| 20              | 3.152 [80.06] | 3.578 [90.88]  | 3.900 [99.06]  | 3.136 [79.65] | 3.302 [83.87] | 2- -0         |
| 21              | 3.308 [84.02] | 3.734 [94.84]  | 4.056 [103.02] | 3.292 [83.62] | 3.458 [87.83] | 2- -1         |
| 22              | 3.464 [87.99] | 3.890 [98.81]  | 4.212 [106.98] | 3.448 [87.58] | 3.614 [91.80] | 2- -2         |
| 23              | 3.620 [91.95] | 4.046 [102.77] | 4.368 [110.95] | 3.604 [91.54] | 3.770 [95.76] | 2- -3         |
| 24              | 3.776 [95.91] | 4.202 [106.73] | 4.524 [114.91] | 3.760 [95.50] | 3.926 [99.72] | 2- -4         |

MTA-156  
.156 [3.96]

## MTA-156 IDC Card Edge Accessories

### Dust Cover

#### Material (RoHS Compliant)

UL94V-0 rated, polyester, white

Cover is for both Closed End and Feed-Thru connectors



#### Cover Ordering Information

The "Base Part Numbers" Chart at right shows the base part number and number of circuits available for the described cover.

Prefixes and suffixes are determined by the number of circuit positions in the cover. For example, the complete part number for a 12-position dust cover would be:

Base number **641106** plus prefix-and-suffix  
**1- — -2**

The correct ordering number is

**1-641106-2**

#### Base Part Number

| Cover Part No. | No. of Circuits            |
|----------------|----------------------------|
| 641106         | 3, 6, 9, 12, 15, 18, 20-24 |

| No. of Circuits | Dim. A         | Prefix/Suffix |
|-----------------|----------------|---------------|
| 3               | .504<br>12.80  | -3            |
| 6               | .972<br>24.69  | -6            |
| 9               | 1.440<br>36.58 | -9            |
| 12              | 1.908<br>48.46 | 1- -2         |
| 15              | 2.376<br>60.35 | 1- -5         |
| 18              | 2.844<br>72.24 | 1- -8         |
| 20              | 3.156<br>80.16 | 2- -0         |
| 21              | 3.312<br>84.12 | 2- -1         |
| 22              | 3.468<br>88.09 | 2- -2         |
| 23              | 3.624<br>92.05 | 2- -3         |
| 24              | 3.780<br>96.01 | 2- -4         |

### Replacement IDC Contacts

#### Material and Finish

Phosphor bronze; post tin plated

#### Part Numbers

- 3-640991-1 (18 AWG [0.8-0.9 mm<sup>2</sup>])
- 3-640992-1 (20 AWG [0.5-0.6 mm<sup>2</sup>])
- 3-640993-1 (22 AWG [0.3-0.4 mm<sup>2</sup>])
- 3-640994-1 (24 AWG [0.2 mm<sup>2</sup>])
- 3-640995-1 (26 AWG [0.12-0.15 mm<sup>2</sup>])



### Locking Plugs

#### Material (RoHS Compliant)

UL94V-2 rated, nylon, white

Part Number 641101-1



**Note:** Contact must be removed to install locking plug.

#### Material (RoHS Compliant)

UL94V-2 rated, nylon, white

Part Number 641293-1



**Note:** Contact can remain during locking plug installation.



**.156 [3.96] Centerline SL-156 Crimp Contacts and Housings**

**Product Facts**

- Rugged wire-to-board interconnection to mate with .045 square or round post headers or staked posts on .156 centers
- Standard Connectors accept wire range of 18–24 AWG [0.9–0.2 mm<sup>2</sup>] and LID Connectors accept wire range of 18–24 AWG [0.9–0.2 mm<sup>2</sup>] and a limited 16 AWG [1.29–1.42 mm<sup>2</sup>] (2550–2800 CMA)
- Two-piece interconnection system (connector/header)
- Housing made of flame retardant nylon
- Available in 1- through 24-position connector configurations
- Connectors are end-to-end stackable
- Wire-to-board system offers polarization with friction lock for positive mating
- Meets the material requirements of Table 23.1 of UL1410 Standard for High-Voltage Television Receivers and Video Productions
- Recognized under the Component Program of Underwriters Laboratories Inc., File No. E28476
- Certified by Canadian Standards Association, File No. LR7189

**Technical Documents**

**Product Specification**  
108-1049, 108-1049-1, 108-1049-2

**Application Specification**  
114-1021



The AMP SL-156 connectors shown on the following pages are designed to mate with .045 [1.14] square or round post headers or staked posts on .156 [3.96] centers.

The wire-to-board connector is a two-piece connector system with the wire crimped to the contact, then inserted into the housing. This product mates with the MTA-156 flat, polarized and friction lock header, or staked posts (not MTA-156 shrouded headers).

**Performance Data**

- Voltage Rating** — 250 vac
- Current Rating** — 10 amp max. at 250 vac
- Low-Level Resistance** — 3.0 mΩ max. initial
- Dielectric Withstanding Voltage** — 2000 vac/1 min.
- Insulation Resistance** — 1000 MΩ min. initial
- Operating Temperature** — -55° C to +105° C

The Large Insulation Diameter (LID) Contacts and Housings are for use in applications where wire insulation is up to .112 [2.84] in diameter.

These matrixes represent only the housing and header combinations. You also need to consider the plating on the contacts and headers. Gold contacts with gold headers and tin contacts with tin headers.

**Matrix for Tin Plated Part Numbers**

|          |          | Headers |        |        |        |        |        |        |        |        |        |        |        |        |        |        |        |        |        |        |        |        |        |        |        |        |        |        |        |
|----------|----------|---------|--------|--------|--------|--------|--------|--------|--------|--------|--------|--------|--------|--------|--------|--------|--------|--------|--------|--------|--------|--------|--------|--------|--------|--------|--------|--------|--------|
| Housings | Standard | LID     | 640383 | 640384 | 640385 | 640387 | 640388 | 640389 | 640445 | 644611 | 644612 | 644613 | 644614 | 644615 | 644616 | 644617 | 644749 | 644750 | 644751 | 644752 | 644753 | 644754 | 644755 | 647227 | 647228 | 647229 | 647230 | 647260 | 647262 |
|          | 640250   | 647401  | Y      | Y      | Y      | N      | Y      | Y      | Y      | Y      | Y      | Y      | N      | Y      | Y      | Y      | Y      | Y      | Y      | Y      | Y      | Y      | Y      | N      | Y      | Y      | Y      | Y      | Y      |
| 640251   | 647400   | Y       | Y      | Y      | Y      | Y      | Y      | Y      | Y      | Y      | Y      | Y      | Y      | Y      | Y      | Y      | Y      | Y      | Y      | Y      | Y      | Y      | Y      | Y      | Y      | Y      | Y      | Y      | Y      |
| 770849   | 647402   | Y       | Y      | Y      | N      | Y      | Y      | Y      | Y      | Y      | Y      | N      | Y      | Y      | Y      | Y      | Y      | Y      | Y      | Y      | Y      | Y      | N      | Y      | Y      | Y      | N      | Y      | Y      |

**Matrix for .000030 [0.00076] Gold Plated Part Numbers**

|          |          | Headers |        |        |        |        |        |        |        |        |        |        |        |        |        |        |        |        |        |        |        |        |        |   |  |
|----------|----------|---------|--------|--------|--------|--------|--------|--------|--------|--------|--------|--------|--------|--------|--------|--------|--------|--------|--------|--------|--------|--------|--------|---|--|
| Housings | Standard | LID     | 641202 | 641203 | 641204 | 641207 | 641208 | 641209 | 641210 | 644627 | 644628 | 644629 | 644630 | 644631 | 644632 | 644633 | 644756 | 644757 | 644758 | 644759 | 644760 | 644761 | 644762 |   |  |
|          | 640250   | 647401  | Y      | Y      | Y      | N      | Y      | Y      | Y      | Y      | Y      | Y      | N      | Y      | Y      | Y      | Y      | Y      | Y      | Y      | Y      | Y      | Y      | N |  |
| 640251   | 647400   | Y       | Y      | Y      | Y      | Y      | Y      | Y      | Y      | Y      | Y      | Y      | Y      | Y      | Y      | Y      | Y      | Y      | Y      | Y      | Y      | Y      | Y      |   |  |
| 770849   | 647402   | Y       | Y      | Y      | N      | Y      | Y      | Y      | Y      | Y      | Y      | N      | Y      | Y      | Y      | Y      | Y      | Y      | Y      | Y      | Y      | Y      | N      |   |  |

**Matrix for .000015 [0.00038] Gold Plated Part Numbers**

|          |          | Headers |        |        |        |        |        |        |        |        |        |        |        |        |        |        |        |        |  |  |  |  |  |  |  |
|----------|----------|---------|--------|--------|--------|--------|--------|--------|--------|--------|--------|--------|--------|--------|--------|--------|--------|--------|--|--|--|--|--|--|--|
| Housings | Standard | LID     | 641113 | 641114 | 641115 | 641118 | 641119 | 641120 | 641121 | 644322 | 644763 | 644764 | 644765 | 644766 | 644767 | 644768 | 644769 | 647261 |  |  |  |  |  |  |  |
|          | 640250   | 647401  | Y      | Y      | Y      | N      | Y      | Y      | Y      | Y      | Y      | Y      | Y      | Y      | Y      | Y      | N      | Y      |  |  |  |  |  |  |  |
| 640251   | 647400   | Y       | Y      | Y      | Y      | Y      | Y      | Y      | Y      | Y      | Y      | Y      | Y      | Y      | Y      | Y      | Y      |        |  |  |  |  |  |  |  |
| 770849   | 647402   | Y       | Y      | Y      | N      | Y      | Y      | Y      | Y      | Y      | Y      | Y      | Y      | Y      | Y      | N      | Y      |        |  |  |  |  |  |  |  |



## SL-156 Crimp Contacts and Keying Plugs

### Contacts

#### Material and Finish

.012 [0.3] bright tin plated brass or phosphor bronze; .012 [0.3] pre-tin brass; or .012 [0.3] brass or phosphor bronze with .000030 [0.00076] gold over nickel (see chart)

- All tin-plated contacts are post lubricated to resist fretting corrosion
- Maximum insulation diameter is .105 [2.67]
- Wire range is 18-30 AWG [0.9-0.06 mm<sup>2</sup>]



#### Application Note

Part No. 640252 has a higher mating and unmating force than Part No. 350980 and is recommended to be used only in housings with 1 through 12 positions.

Part No. 350980 can be used in any size housing but is recommended to be used in housings with 13 through 24 positions.

Part No. 770476 is recommended for use in any size housing. Its mating force is similar to Part No. 350980 while unmating force is similar to 640252.

For housings, see pages 60 and 61.

### Keying Plugs

#### Material (RoHS Compliant)

UL94V-2 rated, nylon, natural color



**Keying Plug**  
Part No. 640254-1



**Keying Pin**  
Part No. 640255-1

| Wire Size<br>AWG mm <sup>2</sup> | Contact | Material and Finish                    | Part Numbers |             |
|----------------------------------|---------|--|--------------|-------------|
|                                  |         |  | Strip        | Loose Piece |
| 24-30<br>0.2-0.06                | A       | brass, pre-tin plated                  | 641550-1     | —           |
|                                  |         | brass, bright tin plated               | 640252-1     | 640706-1    |
|                                  |         | brass, pre-tin plated                  | 640252-2     | 640706-2    |
| 18-24<br>0.9-0.2                 | A       | brass, <b>RoHS Compliant</b>           | 3-640252-1   | 3-640706-1  |
|                                  |         | brass, bright tin plated               | 350980-1     | 640707-1    |
|                                  |         | brass, pre-tin plated                  | 350980-2     | —           |
|                                  | B       | brass, gold plated                     | 350980-3     | 770258-1    |
|                                  |         | brass, <b>RoHS Compliant</b>           | 3-350980-1   | 3-640707-1  |
|                                  |         | phosphor bronze, bright tin plated     | 770476-1     | 770522-1    |
|                                  | C       | phosphor bronze, gold plated           | 770476-2     | 770522-2    |
|                                  |         | phosphor bronze, <b>RoHS Compliant</b> | 3-770476-1   | 3-770522-1  |

#### Application Tooling

Extraction Tool  
Part No. 90471-1

#### Loose Piece Contacts —

PRO-CRIMPER II Hand Tool  
Part No. 58614-1 (408-4228)  
[For field service use only]  
For CERTI-CRIMP hand tool, contact  
Technical Support.

#### Strip Contacts —

AMP-O-LECTRIC Model "G"  
Termination Machine\*  
Applicator 680211-3  
(Request Catalog 65828)  
AMP-O-LECTRIC Model "K"  
Termination Machine\* Applicator  
466468-2  
AMP-O-MATIC Stripper-Crimper  
Machine\* SCA 466947-1 or 567828-1  
(with CQM) (Request Catalog 65004)  
AMPOMATOR CLS IV+ Lead Making  
Machine\* Applicator 466468-1  
(Request Catalog 82659)

\*Requires applicators. For part numbers, call Technical Support.

## SL-156 Housings—Wire-to-Board

### Housings

#### Material (RoHS Compliant)

UL94V-0 rated, nylon, white

#### Notes:

1. Accepts either .045 [1.14] square or round posts. Housings mate with flat and friction lock headers, or staked posts on .156 [3.96] centers.
2. Housings without ramp, with polarizing tab, available upon request. Minimums may apply.
3. Recommend contact:  
Part No. 640252 for 1 thru 12 positions; Part No. 350980 for 13 thru 24 positions; Part No. 770476 for 1 thru 24 positions.



(A) With Locking Ramp/With Polarizing Tabs



(B) With Locking Ramp/Without Polarizing Tabs



(C) Without Locking Ramp/Without Polarizing Tabs

Note: Dim. A = 0.156 × (No. of Positions - 1) + 0.152

For contacts, see page 59.

For mateability options, see matrix on page 58.

For mating half visuals, for connectors with locking ramp, see pages 46, 47, 48, 50 and 52, (49 and 51 Front Bend Headers only.)

For mating half visuals, for connectors without locking ramp, see pages 46 thru 52.

| No. of Positions* | Housing | Description                                   | Part Numbers* |
|-------------------|---------|---|---------------|
| 2-24              | A       | With Locking Ramp and Polarizing Tabs         | 770849        |
| 1-24              | B       | With Locking Ramp and without Polarizing Tabs | 640250        |
|                   | C       | Without Locking Ramp or Polarizing Tabs       | 640251        |

\*Base Part Number Prefixes and Suffixes indicate number of contact positions, e.g. 2 Position = 0-xxxxxx-2 and 12 Position = 1-xxxxxx-2.

Note: Housings not for use with LID Contacts. Shown on page 62.

SL-156  
.156 [3.96]

## SL-156 Housings With Through Board Latch

### Housings

#### Material (RoHS Compliant)

UL94V-2 rated, nylon, white

Mates with .045 square or  
round staked posts only.

For contacts, see page 59



Recommended PC Board Cutout  
for .062 [1.57] Thick PC Board

| No. of Pos. | Dimensions     |                | Latch Location Centered Between Pos. | Part Number |
|-------------|----------------|----------------|--------------------------------------|-------------|
|             | A              | B              |                                      |             |
| 2           | .312<br>7.92   | —              | 1 and 2                              | 770894-2    |
| 3           | .468<br>11.89  | —              | 1 and 2                              | 770894-3    |
| 4           | .624<br>15.85  | —              | 2 and 3                              | 770894-4    |
| 5           | .780<br>19.81  | —              | 2 and 3                              | 770894-5    |
| 6           | .936<br>23.77  | —              | 3 and 4                              | 770894-6    |
| 7           | 1.092<br>27.74 | —              | 3 and 4                              | 770894-7    |
| 8           | 1.248<br>31.70 | —              | 4 and 5                              | 770894-8    |
| 9           | 1.404<br>35.66 | 1.092<br>27.74 | 1 and 2 & 8 and 9                    | 770894-9    |
| 10          | 1.560<br>39.62 | 1.248<br>31.70 | 1 and 2 & 9 and 10                   | 1-770894-0  |

Note: Not for use with LID Contacts. Shown on page 62.

SL-156  
.156 [3.96]

## SL-156 Housings and Contacts for Large Insulation Diameter (LID) Wire

### Housings

#### Material (RoHS Compliant)

UL 94V-0 rated, nylon, white

#### Notes:

1. Accepts Standard and LID contacts.
2. Larger opening in housings eases contact insertion when using wires that have large insulation diameters (.100-.112 [2.54-2.84]).
3. Housings are not End-to-End stackable.

For mateability options, see matrix on page 58.

For mating half visuals, for connectors with locking ramp, see pages 46, 47, 48, 50 and 52, (49 and 51 Front Bend Headers only.)

For mating half visuals, for connectors without locking ramp, see pages 46 thru 52.



Note: Dim. A = 0.156 × (No. of Positions – 1) + 0.19

| No. of Positions* | Description                                   | Part Numbers*                                   |
|-------------------|---|---|
|                   |   | Housings with Larger Openings for Oversize Wire |
| 1-24              | Without Locking Ramp or Polarizing Tabs       | 647400  |
|                   | With Locking Ramp and without Polarizing Tabs | 647401 (shown above)                            |
| 2-24              | With Locking Ramp and Polarizing Tabs         | 647402  |

\*Base Part Number Prefixes and Suffixes indicate number of contact positions, e.g. 2 Position = 0-xxxxx-2 and 12 Position = 1-xxxxx-2.

### Contacts

#### Material and Finish

.012 [0.3] bright tin plated phosphor bronze; .012 [0.3] phosphor bronze with .000030 [0.00076] gold over nickel (see chart)

- All tin-plated contacts are post lubricated to resist fretting corrosion
- Maximum insulation diameter is .112 [2.85]
- Wire range is 18-24 AWG [0.9-0.2 mm<sup>2</sup>] and a limited 16 AWG [1.29-1.42 mm<sup>2</sup>] (2550-2800 CMA)

#### Product Specifications

108-1049-1 and 108-1049-2

#### Application Specification

114-1021

#### Application Tooling

Extraction Tool Part No. 90471-1

#### Loose Piece Contacts —

PRO-CRIMPER II Hand Tool  
Part No. 91368-1 [18-24 AWG]  
Part No. 91369-1 [16 AWG]  
(For field service use only.)  
For CERTI-CRIMP hand tool, contact Technical Support.

#### Strip Contacts —

AMP-O-LECTRIC Model "G"  
Termination Machine\*  
Applicator 1385048-3 [18-24 AWG]  
Applicator 1385219-3 [16 AWG]  
AMP-O-LECTRIC Model "K"  
Termination Machine\*  
Applicator 1385048-2 [18-24 AWG]  
Applicator 1385219-2 [16 AWG]

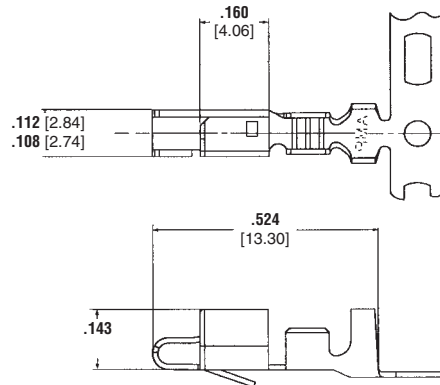

Hooded (Dual Wipe)  
(10 Amp Max. Current Rating)

| Wire Size                      | Material        | Plating        | Part Numbers For LID* Wire |             |
|--------------------------------|-----------------|----------------|----------------------------|-------------|
|                                |                 |                | Strip                      | Loose Piece |
| 18-24 AWG                      | Phosphor Bronze | Tin            | 647406-1                   | 647409-1    |
|                                |                 | Gold           | 647406-2                   | 647409-2    |
|                                |                 | RoHS Compliant | 3-647406-1                 | 3-647409-1  |
| 16 AWG<br>(2550-2800 CMA only) | Phosphor Bronze | Tin            | 647466-1                   | 647485-1    |
|                                |                 | Gold           | 647466-2                   | 647485-2    |
|                                |                 | RoHS Compliant | 3-647466-1                 | 3-647485-1  |

\*Large Insulation Diameter (.100-.112 [2.54-2.84])

Notes: 1. For information on application tooling, call Technical Support.

2. Can **not** be used with Standard SL-156 Housings, must be used with LID Housings only.

\*For additional part numbers and information contact Technical Support.

SL-156  
.156 [3.96]

## AMP Economy Power (EP) Wire-to-Board Connector System

### Product Facts

- .156 [3.96], .200 [5.08] and .312 [7.92] centerline
- Wire-to-board connectors comprised of plug housings, receptacle contacts for discrete wire, and mating post headers
- Hooded contact designed to accept wire with insulation diameters up to .118 [3.00]
- Positive locking feature built into header back wall
- Locking mechanism on connector housing maximizes retention
- Number of positions: 1 to 11 for .156 [3.96] centerline; 2 to 12 for .200 [5.08] centerline; and 2 to 5 for .312 [7.92] centerline
- Straight, through-hole headers
- Positive latch design for easier mating and unmating
- Polarization tabs help prevent post misalignment and mismatching
- Low-profile mating height of .641 [16.3] for 2 to 11 positions
- Straight headers are end-to-end stackable to conserve PCB space
- Header packaging: bulk pack and tube loaded
- Plug housings and post headers intermateable with JST VH connectors
- Directive 2002/95/EC (RoHS Compliant)
- Recognized under the Component Program of Underwriters Laboratories Inc., File No. E28476 
- Certified by Canadian Standards Association, File No. LR 7189 

### Applications

- Household appliances, garage door openers, power supplies, power connections, or other areas requiring additional connector retention



AMP Economy Power (EP) Connectors are designed for secondary power circuit applications. They consist of wire-to-pc board plug housings (for receptacle contacts) and mating post headers. Three contact centerline spacings are available: .156 [3.96], .200 [5.08] and .312 [7.92].

During mating, the positive locking lever on the outside of the plug housing engages the mating header housing to provide for greater retention. This helps maintain reliable connections, when other non-locking type connectors could vibrate apart. This same locking lever must be depressed to unmate the connectors.

The locking mechanism is also located high enough to help avoid interference with pc board clear plastic coating (potting), which is a common treatment for many home appliances.

Headers with .156 [3.96] centerline are offered in 2 through 11 positions; 2 through 12 positions for .200 [5.08] centerline; and .312 [7.92] centerline are available in 2 through 5 positions. Both versions are provided in bulk pack or in tubes for automatic machines.

The slim, straight, post headers are stackable end-to-end for greater flexibility when designing pc board configurations.

The mating height of a low-profile plug and vertical header is .642 [16.3]; even the 1-position high-profile style measures only .732 [18.6] above the pc board. Compact dimensions like these are well suited for most applications in confined spaces.

### Performance Characteristics

**Voltage Rating** — 250 VAC

**Current Rating** — 7.5 amp max. (2 to 11 pos.), 8 amp max. (1 pos.)

**Low Level Overall Resistance**—  
Initial — 10 mΩ max.  
Final — 20 mΩ max.

**Dielectric Withstanding Voltage** —  
1.5 kV AC, 1 min.

**Insulation Resistance** —  
Initial — 1000 MΩ min.  
Final — 500 MΩ min.

**Durability** — 50 mating and unmating cycles

**Operating Temperature** — -13°F to +221°F [-25°C to +105°C]

**Wire Size Range** — 18-22 AWG  
[0.89-0.30 mm<sup>2</sup>]

**Insulation Diameter** — .118 [3.00] max.

### Technical Documents

**Product Specification**

108-5609

**Application Specification**

114-5253

**Instruction Sheet**

411-5899

**AMP Economy Power (EP) Wire-to-Board Connector System (Continued)**

**Contacts and Plug Housings, Low-Profile**

**Crimp, Snap-in Receptacle Contacts**

**Material and Finish (RoHS Compliant)**

See chart.

**Related Product Data**

**Plug Housings** — Pages 64, 67 and 69



| Wire Size Range |                 | Wire Insulation Diameter | Material and Finish | Part Number |             | Applicator Part Number                            |  |                           |
|-----------------|-----------------|--------------------------|---------------------|-------------|-------------|---|--|---------------------------|
| AWG             | mm <sup>2</sup> |                          |                     | Strip Form  | Loose Piece | AMPOMATOR CLS IV+ Lead Maker Base Part No. 356500 | AMP-O-LECTRIC Terminator Model K Part No. 1-471273-3 | Model G Part No. 354500-1 |
| 18-22           | 0.89-0.30       | .067-.118<br>1.70-3.00   | Phos. Brz., Pre-Tin | 1123721-1   | 1318912-1*  | 1385286-1   | 1385286-2  | 1385286-3                 |
|                 |                 |                          | Brass, Pre-Tin      | 1123721-2   | —           |   |  |                           |

\* For 18-20 AWG, use Straight Action Hand Tool (SAHT) Part Number 91579-1.

**Plug Housings, Low-Profile**

**Material and Finish (RoHS Compliant)**

**Housing** — UL 94V-0 rated nylon, natural color

**Note:** Alternate colors available upon request. Minimums may apply. Please contact product engineer or product manager for details.

**Related Product Data**

**Contacts** — see above

**Mating Post Headers** — Pages 65 and 66

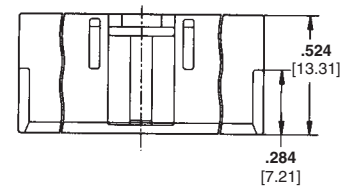

| Number of Positions | Dimension A   | Part Number |
|---------------------|---------------|-------------|
| 2                   | .310 [7.86]   | 1-1123722-2 |
| 3                   | .465 [11.82]  | 1-1123722-3 |
| 4                   | .621 [15.78]  | 1-1123722-4 |
| 5                   | .777 [19.74]  | 1-1123722-5 |
| 6                   | .933 [23.70]  | 1-1123722-6 |
| 7                   | 1.089 [27.66] | 1-1123722-7 |
| 8                   | 1.245 [31.62] | 1-1123722-8 |
| 9                   | 1.401 [35.58] | 1-1123722-9 |
| 10                  | 1.557 [39.54] | 1-1123722-0 |
| 11                  | 1.713 [43.50] | 1-1123722-1 |
| 12                  | 1.878 [47.70] | 1-647690-2* |

\* Consult Product Drawing for dimensional detail.

AMP EP  
.156 [3.96]



**AMP Economy Power (EP) Wire-to-Board Connector System (Continued)**

**Straight and Right-Angle Low-Profile Post Headers**

**.156 [3.96] Centerline**

**Material and Finish (RoHS Compliant)**

**Housing** — UL 94V-0 rated natural color

**Note:** Alternate colors available upon request. Minimums may apply. Please contact product engineer or product manager for details.

**Post** — Tin-plated brass

**Related Product Data**

**Mating Plug Housings** — Page 64

**Straight**



| Number of Positions | Dimension A   | Part Number |                             |                     |
|---------------------|---------------|-------------|-----------------------------|---------------------|
|                     |               | Bulk Pack   | Tube Loaded (Pcs. per Tube) | Bulk Pack with Pegs |
| 2                   | .310 [ 7.86]  | 1-1123723-2 | 1-1318300-2 (61)            | 1744057-2           |
| 3                   | .465 [11.82]  | 1-1123723-3 | 1-1318300-3 (40)            | 1744057-3           |
| 4                   | .621 [15.78]  | 1-1123723-4 | 1-1318300-4 (30)            | 1744057-4           |
| 5                   | .777 [19.74]  | 1-1123723-5 | 1-1318300-5 (24)            | 1744057-5           |
| 6                   | .933 [23.70]  | 1-1123723-6 | 1-1318300-6 (20)            | 1744057-6           |
| 7                   | 1.089 [27.66] | 1-1123723-7 | 1-1318300-7 (17)            | 1744057-7           |
| 8                   | 1.245 [31.62] | 1-1123723-8 | 1-1318300-8 (15)            | 1744057-8           |
| 9                   | 1.401 [35.58] | 1-1123723-9 | 1-1318300-9 (13)            | 1744057-9           |
| 10                  | 1.557 [39.54] | 1-1123723-0 | 1-1318300-0 (12)            | 1-1744057-0         |
| 11                  | 1.713 [43.50] | 1-1123723-1 | 1-1318300-1 (11)            | 1-1744057-1         |
| 12                  | 1.871 [47.52] | 1-647689-2* | —                           | 1-1744057-2         |

\* Consult Product Drawing for dimensional detail.

**.156 [3.96] Centerline**

**Material and Finish (RoHS Compliant)**

**Housing** — UL 94V-0 rated nylon, natural color

**Note:** Alternate colors available upon request. Minimums may apply. Please contact product engineer or product manager for details.

**Post** — Tin-plated brass

**Related Product Data**

**Mating Plug Housings** — Page 64

**Right-Angle**



| Number of Positions | Dimension A   | Part Number |
|---------------------|---------------|-------------|
| 2                   | .312 [ 7.92]  | 647676-2    |
| 3                   | .468 [11.88]  | 647676-3    |
| 4                   | .624 [15.84]  | 647676-4    |
| 5                   | .780 [19.80]  | 647676-5    |
| 6                   | .935 [23.76]  | 647676-6    |
| 7                   | 1.091 [27.72] | 647676-7    |
| 8                   | 1.247 [31.68] | 647676-8    |
| 9                   | 1.403 [35.64] | 647676-9    |
| 10                  | 1.559 [39.60] | 1-647676-0  |
| 11                  | 1.715 [43.56] | 1-647676-1  |
| 12                  | 1.871 [47.52] | 1-647676-2  |

## AMP Economy Power (EP) Wire-to-Board Connector System (Continued)

### Straight and Right-Angle Low-Profile Post Headers, High Temperature

**.156 [3.96] Centerline**

#### Material and Finish (RoHS Compliant)

**Housing** — UL 94V-0 rated nylon, high temperature, natural color

**Note:** Alternate colors available upon request. Minimums may apply. Please contact product engineer or product manager for details.

**Post** — Tin-plated brass

#### Related Product Data

**Mating Plug Housings** — Page 64

### Straight



| Number of Positions | Dimension A   | Part Number |
|---------------------|---------------|-------------|
| 2                   | .312 [ 7.92]  | 1744055-2   |
| 3                   | .468 [11.88]  | 1744055-3   |
| 4                   | .624 [15.84]  | 1744055-4   |
| 5                   | .780 [19.80]  | 1744055-5   |
| 6                   | .935 [23.76]  | 1744055-6   |
| 7                   | 1.091 [27.72] | 1744055-7   |
| 8                   | 1.247 [31.68] | 1744055-8   |
| 9                   | 1.403 [35.64] | 1744055-9   |
| 10                  | 1.559 [39.60] | 1-1744055-0 |
| 11                  | 1.715 [43.56] | 1-1744055-1 |

### Right-Angle



| Number of Positions | Dimension A   | Part Number |
|---------------------|---------------|-------------|
| 2                   | .312 [ 7.92]  | 1744056-2   |
| 3                   | .468 [11.88]  | 1744056-3   |
| 4                   | .624 [15.84]  | 1744056-4   |
| 5                   | .780 [19.80]  | 1744056-5   |
| 6                   | .935 [23.76]  | 1744056-6   |
| 7                   | 1.091 [27.72] | 1744056-7   |
| 8                   | 1.247 [31.68] | 1744056-8   |
| 9                   | 1.403 [35.64] | 1744056-9   |
| 10                  | 1.559 [39.60] | 1-1744056-0 |
| 11                  | 1.715 [43.56] | 1-1744056-1 |
| 12                  | 1.871 [47.52] | 1-1744056-2 |

AMP EP  
.156 [3.96]

**.156 [3.96] Centerline**

#### Material and Finish (RoHS Compliant)

**Housing** — UL 94V-0 rated nylon, high temperature, natural color

**Note:** Alternate colors available upon request. Minimums may apply. Please contact product engineer or product manager for details.

**Post** — Tin-plated brass

#### Related Product Data

**Mating Plug Housings** — Page 64

## AMP Economy Power (EP) Wire-to-Board Connector System (Continued)

### Plug Housings and Post Headers

#### Plug Housings .200 [5.08] Centerline

#### Material and Finish (RoHS Compliant)

**Housing** — UL 94V-0 rated nylon, natural color

**Note:** Alternate colors available upon request. Minimums may apply. Please contact product engineer or product manager for details.

#### Related Product Data

**Contacts** — Page 64

**Mating Post Headers** — See below



| Number of Positions | Dimension A   | Part Number |
|---------------------|---------------|-------------|
| 2                   | .353 [ 8.98]  | 1744036-2   |
| 3                   | .553 [14.06]  | 1744036-3   |
| 4                   | .753 [19.14]  | 1744036-4   |
| 5                   | .953 [24.22]  | 1744036-5   |
| 6                   | 1.153 [29.30] | 1744036-6   |
| 7                   | 1.353 [34.38] | 1744036-7   |
| 8                   | 1.553 [39.46] | 1744036-8   |
| 9                   | 1.753 [44.54] | 1744036-9   |
| 10                  | 1.953 [49.62] | 1-1744036-0 |
| 11                  | 2.153 [54.70] | 1-1744036-1 |
| 12                  | 2.353 [59.78] | 1-1744036-2 |

#### Post Headers .200 [5.08] Centerline

#### Material and Finish (RoHS Compliant)

**Housing** — UL 94V-0 rated nylon, natural color

**Note:** Alternate colors available upon request. Minimums may apply. Please contact product engineer or product manager for details.

Post—Tin-plated brass



#### Related Product Data

**Mating Plug Housings** — See above



| Number of Positions | Dimension A   | Part Number |             |
|---------------------|---------------|-------------|-------------|
|                     |               | Straight    | Right-Angle |
| 2                   | .302 [ 7.68]  | 1744037-2   | 1744048-2   |
| 3                   | .502 [12.76]  | 1744037-3   | 1744048-3   |
| 4                   | .702 [17.84]  | 1744037-4   | 1744048-4   |
| 5                   | .902 [22.92]  | 1744037-5   | 1744048-5   |
| 6                   | 1.102 [28.00] | 1744037-6   | 1744048-6   |
| 7                   | 1.302 [33.08] | 1744037-7   | 1744048-7   |
| 8                   | 1.502 [38.16] | 1744037-8   | 1744048-8   |
| 9                   | 1.702 [43.24] | 1744037-9   | 1744048-9   |
| 10                  | 1.902 [48.32] | 1-1744037-0 | 1-1744048-0 |
| 11                  | 2.102 [53.40] | 1-1744037-1 | 1-1744048-1 |
| 12                  | 2.302 [58.48] | 1-1744037-2 | 1-1744048-2 |

**AMP Economy Power (EP) Wire-to-Board Connector System** (Continued)

**Straight Post Headers,  
Low-Profile**

**.312 [7.92] Centerline**

**Material and Finish  
(RoHS Compliant)**

**Housing** — UL 94V-0 rated natural color

**Note:** Alternate colors available upon request. Minimums may apply. Please contact product engineer or product manager for details.

**Post** — Tin-plated brass

**Related Product Data**

**Mating Plug Housings** — Page 64



| Number of Positions | Dimension A   | Part Number |                             |
|---------------------|---------------|-------------|-----------------------------|
|                     |               | Bulk Pack   | Tube Loaded (Pcs. per Tube) |
| 2                   | .465 [11.82]  | 1-1123724-2 | 1-1318301-2 (40)            |
| 3                   | .777 [19.74]  | 1-1123724-3 | 1-1318301-3 (24)            |
| 4                   | 1.089 [27.66] | 1-1123724-4 | 1-1318301-4 (17)            |
| 5                   | 1.401 [35.58] | 1-1123724-5 | 1-1318301-5 (13)            |

AMP EP  
.312 [7.92]

**Mating Height  
(Low-Profile)**



**AMP Economy Power (EP) Wire-to-Board Connector System (Continued)**

**Plug Housing and Post Header, High-Profile**

**1 Position Plug Housing  
Part Number 1-1123823-1**

**Material and Finish  
(RoHS Compliant)**

**Housing** — UL 94V-0 rated nylon, natural color

**Note:** Alternate colors available upon request. Minimums may apply. Please contact product engineer or product manager for details.



**Related Product Data**

**Contacts** — Page 64

**Mating Post Header** — See below

**1 Position Post Header,  
Straight  
Part Numbers  
1-1123824-1 (Bulk Pack)  
1-1318831-1 (Tube Loaded,  
55 pcs. per Tube)**

**Material and Finish  
(RoHS Compliant)**

**Housing** — UL 94V-0 rated nylon, natural color

**Note:** Alternate colors available upon request. Minimums may apply. Please contact product engineer or product manager for details.

**Post** — Tin-plated brass



**Related Product Data**

**Mating Plug Housing** — See above



**Component Mounting Side**



**Soldering Side**

**Mating Height  
(High-Profile)**



## MTA Wire Selection

Proper wire selection is critical to the success of a wire-to-board application. The chart identifies wires that have been evaluated and approved by the product engineering section. If you plan to use a wire not on the approved list, please submit a sample 12" length of wire to Tyco Electronics for evaluation.

### AWG Metric Equivalents

18—0.8—0.9 mm<sup>2</sup>  
20—0.5—0.6 mm<sup>2</sup>  
22—0.3—0.4 mm<sup>2</sup>  
24—0.2 mm<sup>2</sup>  
26—0.12—0.15 mm<sup>2</sup>  
28—0.08—0.09 mm<sup>2</sup>

### Product Specifications

108-1050 — MTA-100 Connectors  
108-1050-1 — MTA-100 Posted Connectors  
108-1051 — MTA-156 Connectors  
108-1219 — MTA-156 Quad Connector System  
108-1065 — MTA-156 Posted Connectors  
108-1058 — MTA-156 Card Edge Connectors

### Application Specifications

114-1019 — MTA-100 Connectors  
114-1020 — MTA-156 Connectors  
114-1031 — MTA-100 Ribbon Cable Connector Assembly  
114-1032 — MTA-156 Ribbon Cable Connector Assembly  
114-1048 — MTA-156 Quad Connector

### MTA Connectors Approved Wire Listing

| MTA-100 Connectors                       | Wall          | Approved Wire AWG |
|--|---------------|-------------------|
| UL 1007 PVC Insulation                   | .015" [0.381] | 22, 24, 26, 28    |
| UL 1061 Semi-Rigid PVC Insulation        | .009" [0.229] | 22, 24, 26, 28    |
| UL 1095 Semi-Rigid PVC Insulation        | .012" [0.305] | 24                |
| UL 1371 TEFLON Insulation—TFE            | .006" [0.152] | 22, 26            |
| UL 1429 Irradiated PVC—X.L.P.V.C.        | .010" [0.254] | 22, 24, 26, 28    |
| UL 2464 PVC                              | .013" [0.330] | 24                |
| UL 3265 Irradiated Polyethylene—X.L.P.E. | .010" [0.254] | 22, 24            |
| UL 3266 Irradiated Polyethylene—X.L.P.E. | .015" [0.381] | 22, 24            |
| MIL-W-16878, Type B-PVC Insulation       | .010" [0.254] | 22                |
| UL 1213 TEFLON Insulation—T.F.E.         | .010" [0.254] | 22                |
| MTA-156 Connectors                       |               |                   |
| UL 1007 PVC Insulation                   | .015" [0.381] | 18, 20, 22, 24    |
| UL 1061 Semi-Rigid PVC Insulation        | .009" [0.229] | 18, 20, 22, 24    |
| UL 1180 TEFLON Insulation—T.F.E.         | .015" [0.381] | 22                |
| UL 1213 TEFLON Insulation—T.F.E.         | .010" [0.254] | 18, 22, 24        |
| UL 1316 PVC/Nylon Wall                   | .015" [0.381] | 18, 22            |
| UL 1429 Irradiated PVC—X.L.P.V.C.        | .010" [0.254] | 18, 20, 22, 24    |
| UL 1430 Irradiated PVC—X.L.P.V.C.        | .015" [0.381] | 18, 20, 22, 24    |
| UL 1569 PVC                              | .015" [0.381] | 18                |
| UL 3265 Irradiated Polyethylene—X.L.P.E. | .010" [0.254] | 22                |
| UL 3266 Irradiated Polyethylene—X.L.P.E. | .015" [0.381] | 18, 20, 22, 24    |

**Note:** When selecting approved wire styles noted on this list, the MTA Application Specifications guidelines must be followed. Also, due to wire variations in insulation wall thickness, hardness and wire stranding we would recommend evaluating the wire selected before final application approval.

TEFLON is a trademark of E.I. DuPont de Nemours and Company.

### MTA-100 Ribbon Cable Preparation



### MTA-156 Ribbon Cable Preparation

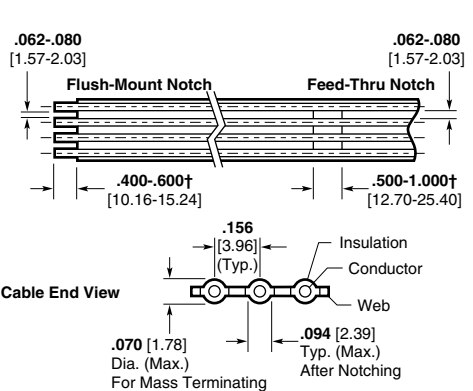

† The dimensions shown represent the recommended minimum and maximum for notches; the actual dimension will depend on your application requirements.

#### Notes:

- Cable shall be notched, as indicated in the individual ribbon cable connector assembly drawing, according to the requirements specified in these figures. Conductor shall not be exposed after notching, nor shall individual wire stands be cut or nicked.
- U.L. Style #2651 ribbon cable is approved for use with MTA-100 and MTA-156 connectors per Application Specification 114-1031 and 114-1032.

### Ribbon Cable





## IDC Ribbon Cable

### Product Facts

- Compatible with a variety of Insulation Displacement Connectors
- Available on .025 [0.63], .0394 [1.00], .050 [1.27], .100 [2.54] and .156 [3.96] centerline
- Color code edge mark on conductor #1
- Gray flame retardant flexible PVC insulation
- Insulation rated for temperature of -20°C to +105°C
- Recognized under the Component Program of Underwriters Laboratories Inc.,  
File No. E53793 



Tyco Electronics Corporation has an expanding array of MADISON CABLE planar PVC insulated product designed for compatibility with a variety of Insulation Displacement Connectors. AMP IDC terminations offer a quick, reliable, cost-effective cabling system which can be automated.

The .100 [2.54] centerline cable is available in 28 to 22 AWG, either as tinned or as overcoated tinned wire, in 2 to 28 conductors.

The .156 [3.96] centerline is available in 22 AWG and 18 AWG, either as tinned or overcoated tinned, in 2 to 24 conductors.

IDC Ribbon Cable is produced to tighter standards than usually required for high yield insulation displacement terminations. The extra precision offers uncomplicated operation in fully automatic stripping, notching and termination equipment.

### .050 [1.27] Centerline, IDC Ribbon Cable

#### Product Specifications

**Voltage Rating** — 30 VAC

**Component Recognized by UL to US and Canadian Standards** —  
AWM Style 2651

#### Sizes —

**26 AWG**, 7/34 Tinned copper, PVC insulation (9 – 64 conductors), 500-ft reels (Base AMP Part Number 57034)

**28 AWG**, 7/36 Tinned copper, PVC insulation (9 – 64 conductors), 100-ft reels (Base AMP Part Number 57040) and 500-ft reels (Base AMP Part Number 971111)

**30 AWG**, Other conductor counts available on request. For ordering information, call Toll-Free: **1-877-623-4766** or visit: <http://www.madisoncable.com/fsproducts.htm>

**.100 [2.54] Centerline, IDC Ribbon Cable, PVC Insulation**

**Product Specifications**

**Voltage Rating** — 300 Volts  
**UL Recognized** — AWM Style 2651  
**CSA** — Available on request



| No. of Conductors                           | Dimensions    |               |              | Part Number  |
|---|---------------|---------------|--------------|--------------|
|   | A             | B             | C            |              |
| <b>28 AWG 7/32 Tinned Copper</b>            |               |               |              |              |
| 2   | 0.100 [2.54]  | 0.200 [5.08]  | 0.044 [1.12] | 02WFFY00006P |
| 5   | 0.400 [10.16] | 0.500 [12.70] | 0.044 [1.12] | 05WFFY00006P |
| 10  | 0.900 [22.86] | 1.000 [25.40] | 0.044 [1.12] | 10WFFY00006P |
| 15  | 1.400 [35.56] | 1.500 [38.10] | 0.044 [1.12] | 15WFFY00006P |
| 20  | 1.900 [48.26] | 2.000 [50.80] | 0.044 [1.12] | 20WFFY00006P |
| 25  | 2.400 [60.96] | 2.500 [63.50] | 0.044 [1.12] | 25WFFY00006P |
| 28  | 2.700 [68.58] | 2.800 [71.12] | 0.044 [1.12] | 28WFFY00006P |
| <b>26 AWG 7/34 Tinned Copper</b>            |               |               |              |              |
| 2   | 0.100 [2.54]  | 0.200 [5.08]  | 0.039 [.99]  | 02WEY00008P  |
| 5   | 0.400 [10.16] | 0.500 [12.70] | 0.039 [.99]  | 05WEY00004P  |
| 10  | 0.900 [22.86] | 1.000 [25.40] | 0.039 [.99]  | 10WEY00012P  |
| 15  | 1.400 [35.56] | 1.500 [38.10] | 0.039 [.99]  | 15WEY00002P  |
| 20  | 1.900 [48.26] | 2.000 [50.80] | 0.039 [.99]  | 20WEY00008P  |
| 25  | 2.400 [60.96] | 2.500 [63.50] | 0.039 [.99]  | 25WEY00008P  |
| 28  | 2.700 [68.58] | 2.800 [71.12] | 0.039 [.99]  | 28WEY00008P  |
| <b>26 AWG 7/34 Overcoated Tinned Copper</b> |               |               |              |              |
| 2   | 0.100 [2.54]  | 0.200 [5.08]  | 0.039 [.99]  | 02WEY00007P  |
| 5   | 0.400 [10.16] | 0.500 [12.70] | 0.039 [.99]  | 05WEY00007P  |
| 10  | 0.900 [22.86] | 1.000 [25.40] | 0.039 [.99]  | 10WEY00007P  |
| 15  | 1.400 [35.56] | 1.500 [38.10] | 0.039 [.99]  | 15WEY00007P  |
| 20  | 1.900 [48.26] | 2.000 [50.80] | 0.039 [.99]  | 20WEY00007P  |
| 25  | 2.400 [60.96] | 2.500 [63.50] | 0.039 [.99]  | 25WEY00007P  |
| 28  | 2.700 [68.58] | 2.800 [71.12] | 0.039 [.99]  | 28WEY00007P  |

| No. of Conductors                           | Dimensions    |               |              | Part Number  |
|---|---------------|---------------|--------------|--------------|
|   | A             | B             | C            |              |
| <b>24 AWG 7/32 Overcoated Tinned Copper</b> |               |               |              |              |
| 2   | 0.100 [2.54]  | 0.200 [5.08]  | 0.044 [1.12] | 02WFFY00007P |
| 5   | 0.400 [10.16] | 0.500 [12.70] | 0.044 [1.12] | 05WFFY00007P |
| 10  | 0.900 [22.86] | 1.000 [25.40] | 0.044 [1.12] | 10WFFY00007P |
| 15  | 1.400 [35.56] | 1.500 [38.10] | 0.044 [1.12] | 15WFFY00007P |
| 20  | 1.900 [48.26] | 2.000 [50.80] | 0.044 [1.12] | 20WFFY00007P |
| 25  | 2.400 [60.96] | 2.500 [63.50] | 0.044 [1.12] | 25WFFY00007P |
| 28  | 2.700 [68.58] | 2.800 [71.12] | 0.044 [1.12] | 28WFFY00007P |
| <b>22 AWG 7/30 Tinned Copper</b>            |               |               |              |              |
| 2   | 0.100 [2.54]  | 0.200 [5.08]  | 0.051 [1.30] | 02WGY00001P  |
| 5   | 0.400 [10.16] | 0.500 [12.70] | 0.051 [1.30] | 05WGY00006P  |
| 10  | 0.900 [22.86] | 1.000 [25.40] | 0.051 [1.30] | 10WGY00002P  |
| 15  | 1.400 [35.56] | 1.500 [38.10] | 0.051 [1.30] | 15WGY00006P  |
| 20  | 1.900 [48.26] | 2.000 [50.80] | 0.051 [1.30] | 20WGY00006P  |
| 25  | 2.400 [60.96] | 2.500 [63.50] | 0.051 [1.30] | 25WGY00006P  |
| 28  | 2.700 [68.58] | 2.800 [71.12] | 0.051 [1.30] | 28WGY00006P  |

Other Conductor Counts Available on Request.

Contact MADISON CABLE (1-877-MADISON), a Division of Tyco Electronics Corporation, for engineering questions or for order placement of this cable.

IDC  
Ribbon Cable

## .156 [3.96] Centerline, Flat Ribbon Cable, PVC Insulation

### Product Specifications

**Voltage Rating** — 300 Volts  
**UL Recognized** — AWM Style 2651  
**CSA** — Available on request



| No. of<br>Conductors             | Dimensions    |               |              | Part<br>Number |
|----------------------------------|---------------|---------------|--------------|----------------|
|                                  | A             | B             | C            |                |
| <b>22 AWG 7/30 Tinned Copper</b> |               |               |              |                |
| 2                                | 0.156 [3.96]  | 0.312 [7.92]  | 0.051 [1.30] | 02WGY00008P    |
| 5                                | 0.624 [15.85] | 0.780 [19.81] | 0.051 [1.30] | 05WGY00008P    |
| 10                               | 1.404 [35.66] | 1.560 [39.62] | 0.051 [1.30] | 10WGY00008P    |
| 15                               | 2.184 [55.47] | 2.340 [59.44] | 0.051 [1.30] | 15WGY00008P    |
| 20                               | 2.964 [75.29] | 3.120 [79.25] | 0.051 [1.30] | 20WGY00008P    |
| 24                               | 3.588 [91.14] | 3.744 [95.10] | 0.051 [1.30] | 24WGY00008P    |
| <b>18 AWG 7/26 Tinned Copper</b> |               |               |              |                |
| 2                                | 0.156 [3.96]  | 0.312 [7.92]  | 0.068 [1.73] | 02WJY000001P   |
| 5                                | 0.624 [15.85] | 0.780 [19.81] | 0.068 [1.73] | 05WJY000010P   |
| 10                               | 1.404 [35.66] | 1.560 [39.62] | 0.068 [1.73] | 10WJY000010P   |
| 15                               | 2.184 [55.47] | 2.340 [59.44] | 0.068 [1.73] | 15WJY000010P   |
| 20                               | 2.964 [75.29] | 3.120 [79.25] | 0.068 [1.73] | 20WJY000010P   |
| 24                               | 3.588 [91.14] | 3.744 [95.10] | 0.068 [1.73] | 24WJY000010P   |

Other Conductor Counts Available on Request.

**Contact MADISON CABLE (1-877-MADISON), a Division of Tyco Electronics Corporation, for engineering questions or for order placement of this cable.**

## Prepared IDC Ribbon Cable



In addition to bulk cable, the US Engineering Cable Assembly Group offers Prepared Cable for the .100 [2.54] and .156 [3.96] centerline cables. This can be in the form of prenotched cable on reels or cut-to-length cable segments.

Prenotched 250 foot reels of cable can be produced with notches at varying increments or repeating all along the cable. The maximum width of these cables

is 20 conductor for the .100 [2.54] centerline and 13 conductor for the .156 [3.96] centerline.

Prepared Cable is also available with a Strip and Retain feature allowing the cable assembly to be soldered directly to the PC Board. This saves space and cost and reduces spare parts inventory. Strip and Retain on both ends is used in family board applications to maintain the

electrical connection when the PC Board is separated into smaller boards after soldering. Widths are limited to 20 conductors for the .100 [2.54] centerline and 13 conductors for the .156 [3.96] centerline. However, multiple cables can be placed side-by-side in a single connector. For other styles and configurations contact the product engineer or product manager.



**MTA Wire Termination Flowchart**

Choose the appropriate MTA Connector from the MTA Catalog 82056.

Select the proper wire style and AWG for the chosen MTA Connector  
(Refer to pages 70-74).

Choose the MTA Termination Tooling (Refer to pages 76-79).

Terminate the Wire-to-MTA Connector per Application Tooling Instruction Sheet.

Inspect the MTA Wire Termination per Application Specification, especially the wire depth. See illustrations: 114-13072 — MTA-50 Connectors, 114-1019 — MTA-100 Connectors, 114-1020 — MTA-156 Connectors, Posted Connector, Card Edge, 114-1048 — MTA-156 Quad Connectors, 114-1031 — MTA-100 Ribbon Cable Connector Assembly, and 114-1032 — MTA-156 Ribbon Cable Connector Assembly.



| Connector | A                        | B              |
|-----------|--------------------------|----------------|
| MTA-100   | .069-.087<br>[1.75-2.21] | .040<br>[1.02] |
| MTA-156   | .090-.113<br>[2.29-2.87] | .060<br>[1.52] |

Adjust the Termination Tooling (if needed) per Tooling Instruction Sheet  
(repeat the step above).

## MTA Application Tooling Options

### One-At-A-Time Termination Tooling Part Numbers

Note: Max. Insulation Outside Diameter Wire:  
.060 [1.52] for MTA-100 Connectors/.095 [2.41] for MTA-156 Connectors

| MTA Connector Assembly | Interchangeable Head   |   | Interchangeable Head and Loose-Piece Feed Track | Interchangeable Head and Tape Feed Track | Special Applicator | T-Handle Maintenance Tool | Notes:   |
|------------------------|--|---|---|--|--------------------|---------------------------|--|
|                        | Manual Hand Tool 58074-1<br>Air Hand Tool 58075-1<br>Air Bench Mount Tool 58338-1<br>Electric Bench Machine 931800-1 | Part Number   |   |  |                    |                           |  |
| MTA-50                 | Closed End   | 1583503-1   | —   | —  | —                  | —                         | <ol style="list-style-type: none"> <li>A repair kit consists of a cam, a feed-slide sub-assembly and a locating pawl. Repair kits can be made available for other interchangeable heads. Consult Tyco Electronics.</li> <li>Standard modular heads 58246-1 and 58247-1 are recommended for low volume use.</li> <li>Extended wear modular heads 58246-2 and 58247-2 are recommended for high volume use.</li> <li>T-Handle Maintenance Tools are for maintenance (field) use only. They are not recommended for production.</li> <li>Some Manual Hand Tool Assemblies are available:               <ol style="list-style-type: none"> <li>Order 58579-1, comprised of Head 58246-1 with Manual Hand Tool 58074-1.</li> <li>Order 58580-1, comprised of Head 58247-1 with Manual Hand Tool 58074-1.</li> <li>Order 58639-1, comprised of Head 58638-1 with Manual Hand Tool 58074-1.</li> </ol> </li> </ol> |
|                        | Feed Thru  | 58246-1 (Standard)*<br>58246-2 (Ext Wear)<br>58246-3 (Ribbon Cable) | —   | —  | —                  | —                         |  |
| MTA-100 Connector      | Closed End   | 933567-1  | 853546-1 & 853542-1 (Base)                      | 466728-1                                 | 59803-1            |                           |  |
|                        | Feed Thru  | 58442-1   | —   | —  | 59803-1            |                           |  |
|                        | Posted (Closed-End)  | 58638-1   | —   | —  | 59803-1            |                           |  |
| MTA-156 Connector      | Closed End   | 933568-1  | 853547-1 & 853542-1 (Base)                      | 466727-1                                 | 59804-1            |                           |  |
|                        | Feed Thru  | 58443-1   | —   | —  | 59804-1            |                           |  |
|                        | Posted (Closed-End)  | 58082-1   | —   | —  | 59804-1            |                           |  |
|                        | Card-Edge  | 58061-1   | —   | —  | 567020-1           |                           |  |
| MTA-156 Quad           | Closed End   | 58392-1   | —   | —  | 59804-1            |                           |  |

\*Repair Kit 856600-1 \*\*Repair Kit 856600-2

### MTA-50 Mass Termination Tooling Part Numbers

|  |   |
|--|---|
| Manual Arbor Frame (with slide)<br>Part Number 1583518-1*  | Fixture, Discrete Wire, Feed-Thru<br>Part Number 1583516-1 (28-26 AWG)<br>Part Number 1583516-2 (30-28 AWG) |
| Upper Tooling<br>Part Number 1583514-1*  | Fixture, Ribbon Cable, Closed End or Feed-Thru<br>Part Number 1583517-1                                     |
| Fixture, Discrete Wire, Closed End<br>Part Number 1583515-1 (28-26 AWG)<br>Part Number 1583515-2 (30-28 AWG) | *Required, plus appropriate Fixture(s).   |

### MTA-100 and MTA-156 Mass Termination Tooling Part Numbers

Note: Max. Insulation Outside Diameter Wire:  
.050 [1.27] for MTA-100 Connectors/.070 [1.78] for MTA-156 Connectors

| MTA Connector Assembly | Interchangeable Head |  | Harness Board Holding Fixture |                     |  | Interchangeable Head and Tape Feed Track |  |   |
|------------------------|----------------------|--|-------------------------------|---------------------|--|--|--|---|
|                        | Part Number          | Used With  | Part Number                   | Applicator Assembly | Tooling Assembly                                       | Part Number                              | Used With  |   |
| MTA-100 Connector      | Closed End           | —  | 58242-1<br>58242-3            | —<br>58575-1        | Manual Bench Tool 58024-1 and Tooling Assembly 58039-1 | 854175-1 & 854200-1 (Base)               | 312522-1   |   |
|                        | Feed Thru            | 58644-1 (Discrete Wire) <sup>†</sup><br>58644-2 (Notched Cable) <sup>†</sup>   | 58074-1 (Man Hd TI)           | 58243-1<br>58243-3  |  | —<br>58575-1                             | —  | — |
|                        | Closed End (Posted)  | —  | —                             | 58635-1             |  | 58575-1                                  | —  | — |
|                        | Feed Thru (Posted)   | —  | —                             | 58636-1             |  | 58575-1                                  | —  | — |
| MTA-156 Connector      | Closed End           | —  | 58244-1<br>58244-3            | —<br>58576-1        | Manual Bench Tool 58024-1 and Tooling Assembly 58040-1 | 854176-1 & 854200-1 (Base)               | 312522-1   |   |
|                        | Feed Thru            | 58646-1 (Discrete Wire) <sup>††</sup><br>58646-2 (Notched Cable) <sup>††</sup> | 58074-1 (Man Hd TI)           | 58245-1<br>58245-3  |  | —<br>58576-1                             | —  | — |
|                        | Card Edge            | —  | —                             | 59848-1<br>59848-3  |  | —<br>58576-1                             | —  | — |
|                        | Closed End (Posted)  | —  | —                             | 58009-1<br>58009-2  |  | —<br>58576-1                             | —  | — |
|                        | Feed Thru (Posted)   | —  | —                             | 58010-2             |  | 58576-1                                  | —  | — |
|                        | Quad                 | —  | —                             | 58244-1<br>58244-3  |  | —<br>58576-1                             | Manual Bench Tool 58024-1 and Tooling Assy 58040-1 | — |
| MTA-156 Quad           | Closed End           | —  | —                             | —                   | 58024-1 and Tooling Assy 58040-1                       | —  | —  |   |
|                        | Feed Thru            | —  | —                             | 58245-1<br>58245-3  |  | —<br>58576-1                             | —  | — |

<sup>†</sup>2- through 12-positions. <sup>††</sup>2- through 8-positions.



**MTA Application Tooling Options** (Continued)

**One-At-A-Time Termination  
Tooling (Typical Tooling  
Combinations)**



Manual Hand Tool with  
Interchangeable Head



Air Hand Tool with  
Interchangeable Head



Air Bench Mount Tool with  
Interchangeable Head and  
Foot Switch



Electric Bench Machine with  
Interchangeable Head

**Power Units**

**Manual Hand Tool —  
Pistol Grip Handle  
Part No. 58074-1**

- Easy to use
- Ratchet control will not release the trigger until it is fully bottomed
- Head may be rotated for user convenience

**Air Hand Tool —  
Pistol Grip Pneumatic Handle  
Part No. 58075-1**

- Light weight
- Operates at air pressure between 40 and 70 psi [2.76 and 4.83 bar]
- Head may be rotated for user convenience

**Air Bench Mount Tool —  
Bench Mount Power Assembly  
Part No. 58338-1**

- May be mounted with interchangeable head pointed up or down
- Operated by a foot switch
- Operates at air pressure between 40 and 70 psi [2.76 and 4.83 bar]

**Electric Bench Machine —  
IDC Power Unit  
Part No. 931800-1**

- All electric: 120 VAC, 60 Hz, 2 A
- Compact, portable and quiet
- Operated by a foot switch

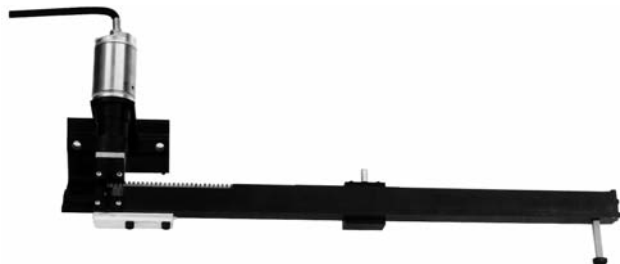

Air Bench Mount Tool with  
Interchangeable Head and Loose-Piece Feed Track



Electric Bench Machine with  
Interchangeable Head and  
Tape Feed Track



AMP-O-LECTRIC Bench  
Machine with Special Applicator

**Interchangeable Heads and Applicators** (Refer to page 76 for part numbers.)

**Interchangeable Head**

- Terminates one unstripped wire per cycle
- Aligns and holds the connector in place for each termination
- Automatically advances the connector after each termination



**Interchangeable Head and  
Loose-Piece Feed Track**

- No special setup required
- Connectors are easily loaded into feed track
- Connectors are fed using a simple spring-loaded pusher

**T-Handle Maintenance Tool**

**Interchangeable Head and  
Tape Feed Track**

- No special setup required
- Tape-mounted connectors are transferred from product reel to feed track by simply pulling on the free end of the carrier tape
- Connectors are fed using a simple spring-loaded pusher

**Special Applicator**

- Connectors are easily hand loaded into feed track
- Automatically advances the connector after each termination
- Cannot be cycled until the connector is properly positioned

**MTA Application Tooling Options** (Continued)

**Mass Termination Tooling**  
(Typical Tooling Combinations)



Manual Bench Tool with Applicator and Holding Fixture



Air Harness Tool with Applicator



Air Bench Machine



2700 lb Air Bench Machine with Ribbon Cable Notcher Assembly

**Power Units**

**Manual Bench Tool — Arbor Frame Assembly**  
Part No. 58024-1

- Applicator and holding fixture can be oriented for operator convenience for closed-end or feed-thru terminations
- Ram height (insertion depth) is easily adjusted
- May be bench mounted

**Air Harness Tools — Hand-Held Power Unit with Applicator**  
Part No. 58575-1 (MTA-100)  
Part No. 58576-1 (MTA-156)

- Applicator can be rotated 360° for orientation with holding fixture
- Insertion depth is easily adjusted
- Operates at air pressure between 75 and 95 psi [5.17 and 6.55 bar]

**Air Bench Machine — Pneumatic Unit**  
Part No. 91112-2

- Operated by a foot switch
- Operates at air pressure between 80 and 90 psi [5.52 and 6.21 bar]
- Not recommended for notching cable with more than 14 conductors

**2700 lb Air Bench Machine — Part No. 312522-1**

- Operated by a foot switch
- Capable of exerting 2,700 lb [12,000 N] of force at minimum 80 psi [5.52 bar] air pressure
- May be bench mounted

**Applicators and Notcher Assemblies**



Manual Bench Tool with Applicator and Tape Feed Track

**Applicator and Holding Fixture**

- Wires are laced into plastic combs for mass termination
- Trims excess wire for closed-end terminations
- Holding fixture may be mounted to a harness board

**Applicator and Tape Feed Track**

- Tape-mounted connectors are transferred from product reel to feed track by simply pulling on the free end of the carrier tape
- Connectors are fed using a simple spring-loaded pusher
- Feed stop easily adjusted for different connector sizes

**Ribbon Cable Notcher Assembly**

- Notch cable with up to 28 conductors for .100 centerline, and 24 conductors for .156 centerline
- Pressure plate holds cable in position during notching
- Scrap conveniently removed through a chute with a blast of air from a built-in air valve



Ribbon Cable Notcher Assembly

| Part Number | Wire Size AWG | Centerline   | Used With   |
|-------------|---------------|--------------|---|
| 854449-2    | 26-28         | .100<br>2.54 | Manual Bench Tool 58024-1   |
| 854449-4    | 22-28         | .100<br>2.54 | Air Bench Machine 91112-2   |
| 854449-3    | 18-24         | .156<br>3.96 | 2700 lb Bench Machine 312522-1<br>AMP-O-LECTRIC Bench Machine 1-471273-3 (with Conversion Kit 690675-2) |

Use Adapter 854468-1 when putting Notcher in the AMP-O-LECTRIC Machine. Use Adapter 854468-2 when putting Notcher in the 2700 lb Air Bench Machine.

## MTA Application Tooling Options (Continued)

### Technical Documents

The following is a list of technical documents covering the installation, operation, adjustment, maintenance and repair of MTA application tooling.

**Instruction Sheets (IS)** provide instructions for assembling or applying the product. They are intended for the Manufacturing Assembler or Operator.

**Customer Manuals (CM)** provide complete, detailed instructions on the installation, operation, adjustment, maintenance and repair of complex tools and application machines.

**Applicator Instructions (AI)** are similar to instruction sheets (which cover products and tools), and provide instructions for installation, adjustment and maintenance of applicators used in automatic and semiautomatic machines.

### Hand Tools, Power Units & Accessories

|                                     |           |             |                               |            |             |
|-------------------------------------|-----------|-------------|-------------------------------|------------|-------------|
| Manual Arbor Frame (MTA-50)         | 1583518-1 | IS 408-8812 | 2700 lb Air Bench Machine     | 312522-1   | CM 409-5843 |
| Upper Tooling (MTA-50)              | 1583514-1 | IS 408-8812 | Terminator Assembly, "G" Term | 354500-1   | CM 409-5842 |
| Manual Arbor Frame Assembly         | 58024-1   | IS 408-6923 | AMP-O-LECTRIC Bench Machine   | 1-471273-3 | CM 409-5128 |
| Ribbon Cable Applicator, .100       | 58039-1   | IS 408-6685 | Conversion Kit                | 690675-2   | IS 408-8022 |
| Ribbon Cable Applicator, .156       | 58040-1   | IS 408-6701 | Base Assembly                 | 853542-1   | IS 408-9636 |
| Manual Hand Tool                    | 58074-1   | IS 408-6790 | Base                          | 854200-1   | IS 408-9650 |
| Air Bench Mount Tool                | 58338-1   | IS 408-9393 | Adapter (AMP-O-LECTRIC)       | 854468-1   | IS 408-9687 |
| Air Hand Tool (MTA-100)             | 58575-1   | IS 408-4260 | Adapter (2700 lb Machine)     | 854468-2   | IS 408-9687 |
| Air Harness Tool (MTA-156)          | 58576-1   | IS 408-4260 | Repair Kit                    | 856600-1   | IS 408-9745 |
| T-Handle Maintenance Tool (MTA-100) | 59803-1   | IS 408-7907 | Repair Kit                    | 856600-2   | IS 408-9745 |
| T-Handle Maintenance Tool (MTA-156) | 59804-1   | IS 408-7907 | Electric Bench Mount Tool     | 931800-1   | CM 409-5746 |
| Air Arbor Frame Assembly            | 91112-2   | IS 408-7763 |                               |            |             |

### One-At-A-Time Termination Tooling

#### Interchangeable Heads

| MTA-50    |             | MTA-156 |             |
|-----------|-------------|---------|-------------|
| 1583503-1 | IS 408-8801 | 58247-1 | IS 408-6930 |
|           |             | 58247-2 | IS 408-9380 |
| MTA-100   |             | 58247-3 | IS 408-4146 |
| 58246-1   | IS 408-6929 | 58443-1 | IS 408-9607 |
| 58246-2   | IS 408-9379 | 58061-1 | IS 408-6794 |
| 58246-3   | IS 408-4147 | 58082-1 | IS 408-6795 |
| 58442-1   | IS 408-9603 | 58392-1 | IS 408-9450 |
| 58638-1   | IS 408-4358 |         |             |

#### Interchangeable Head & Loose Piece Feed Track

| MTA-100  |             | MTA-156  |             |
|----------|-------------|----------|-------------|
| 933567-1 | IS 408-9435 | 933568-1 | IS 408-9466 |

#### Interchangeable Heads & Tape Feed Track

| MTA-100  |             | MTA-156  |             |
|----------|-------------|----------|-------------|
| 853546-1 | IS 408-9636 | 853547-1 | IS 408-9637 |

#### Special Applicators

| MTA-100  |             | MTA-156  |             |
|----------|-------------|----------|-------------|
| 466728-1 | AI 408-8054 | 466727-1 | AI 408-8054 |
|          |             | 567020-1 | AI 408-8069 |

### Mass Termination Tooling

| MTA-50    |             | MTA-100 |             | MTA-156 |             | Die Set Assembly |             |
|-----------|-------------|---------|-------------|---------|-------------|------------------|-------------|
| 1583515-1 | IS 408-8812 | 58242-1 | IS 408-7994 | 58009-1 | IS 408-7995 | 854175-1         | IS 408-9667 |
| 1583515-2 | IS 408-8812 | 58242-3 | IS 408-7994 | 58009-2 | IS 408-7995 |                  |             |
| 1583516-1 | IS 408-8812 | 58243-1 | IS 408-7994 | 58010-2 | IS 408-7995 |                  |             |
| 1583516-2 | IS 408-8812 | 58635-1 | IS 408-7994 | 58244-1 | IS 408-7995 | 854176-1         | IS 408-9650 |
| 1583517-1 | IS 408-8812 | 58636-1 | IS 408-7994 | 58244-3 | IS 408-7995 |                  |             |
|           |             | 58644-1 | IS 408-4406 | 58245-1 | IS 408-7995 |                  |             |
|           |             | 58644-2 | IS 408-4440 | 58245-3 | IS 408-7995 |                  |             |
|           |             | 59844-1 | IS 408-7994 | 58646-1 | IS 408-4405 |                  |             |
|           |             | 59845-1 | IS 408-7994 | 58646-2 | IS 408-4439 |                  |             |
|           |             | 59845-3 | IS 408-7994 | 59848-1 | IS 408-7995 |                  |             |
|           |             |         |             | 59848-3 | IS 408-7995 |                  |             |

### Typical Application Rates

#### Produce 6-in. [15 cm] Long Jumpers, One 4-Position MTA-100 Connector per End, Discrete Wire

| Method   | Terminations Per Hour |
|--|-----------------------|
| Manual Hand Tool 58074-1 with Interchangeable Head 58246-1   | —                     |
| Electric Bench Machine 931800-1 with Interchangeable Head 58246-1  | 900                   |
| Electric Bench Machine 931800-1 with Interchangeable Head and Loose-Piece Feed Track 933567-1              | 1,100                 |
| Electric Bench Machine 931800-1 with Interchangeable Head and Tape Feed Track 853546-1 and 853542-1 (Base) | 1,250                 |

#### Apply One 4-Position MTA-100 Feed-Thru Connector per Assembly, Discrete Wire

| Method  | Terminations Per Hour |
|---|-----------------------|
| Manual Bench Tool 58024-1 with Applicator and Holding Fixture | 650                   |

For further information about tooling call Technical Support.

#### Produce 6-in. [15 cm] Long Jumpers, One 4-Position MTA-100 Connector per End, Ribbon Cable\*

| Method  | Terminations Per Hour |
|---|-----------------------|
| 2700 lb Air Bench Machine 312522-1 with Applicator and Tape Feed Track 854175-1 and 854200-1 (Base) | 7,500                 |

\* Procedure: Mass terminate 12-conductor ribbon cable with three connectors per end. After terminating, separate by tearing the 12-conductor assembly into three 4-conductor assemblies.

#### Cable Notching

| Method  | Cable Ends Per Hour |
|---|---------------------|
| 2700 lb Air Bench Machine 312522-1 with Ribbon Cable Notcher Assembly 854449-2 and 854468-2 (Adapter) | 1,000               |

## Part Number Index

**Note:** This index lists all cataloged parts by base no. only. Complete part nos. (with prefixes and/or suffixes) are shown on the page(s) indicated.

| Part No.     | Page   |
|--------------|--------|
| 02WEY00007P  | 72     |
| 02WEY00008P  | 72     |
| 02WFY00006P  | 72     |
| 02WFY00007P  | 72     |
| 02WGY00001P  | 72     |
| 02WGY00008P  | 73     |
| 02WJY000001P | 73     |
| 05WEY00004P  | 72     |
| 05WEY00007P  | 72     |
| 05WFY00006P  | 72     |
| 05WFY00007P  | 72     |
| 05WGY00006P  | 72     |
| 05WGY00008P  | 73     |
| 05WJY000010P | 73     |
| 10WEY00007P  | 72     |
| 10WEY00012P  | 72     |
| 10WFY00006P  | 72     |
| 10WFY00007P  | 72     |
| 10WGY00002P  | 72     |
| 10WGY00008P  | 73     |
| 10WJY000010P | 73     |
| 15WEY00002P  | 72     |
| 15WEY00007P  | 72     |
| 15WFY00006P  | 72     |
| 15WFY00007P  | 72     |
| 15WGY00006P  | 72     |
| 15WGY00008P  | 73     |
| 15WJY000010P | 73     |
| 20WEY00007P  | 72     |
| 20WEY00008P  | 72     |
| 20WFY00006P  | 72     |
| 20WFY00007P  | 72     |
| 20WGY00006P  | 72     |
| 20WGY00008P  | 73     |
| 20WJY000010P | 73     |
| 24WGY00008P  | 73     |
| 24WJY000010P | 73     |
| 25WEY00007P  | 72     |
| 25WEY00008P  | 72     |
| 25WFY00006P  | 72     |
| 25WFY00007P  | 72     |
| 25WGY00006P  | 72     |
| 28WEY00007P  | 72     |
| 28WEY00008P  | 72     |
| 28WFY00006P  | 72     |
| 28WFY00007P  | 72     |
| 28WGY00006P  | 72     |
| 57034        | 71     |
| 57040        | 71     |
| 350980       | 59, 60 |
| 640250       | 60     |
| 640251       | 60     |
| 640252       | 59, 60 |
| 640383       | 46     |
| 640384       | 46     |
| 640385       | 47     |
| 640387       | 49     |
| 640388       | 48     |

| Part No. | Page |
|----------|------|
| 640389   | 49   |
| 640426   | 37   |
| 640427   | 37   |
| 640428   | 37   |
| 640429   | 37   |
| 640430   | 37   |
| 640431   | 37   |
| 640432   | 37   |
| 640433   | 37   |
| 640434   | 37   |
| 640435   | 37   |
| 640440   | 15   |
| 640441   | 15   |
| 640442   | 15   |
| 640443   | 15   |
| 640445   | 48   |
| 640452   | 21   |
| 640453   | 21   |
| 640454   | 23   |
| 640455   | 23   |
| 640456   | 24   |
| 640457   | 24   |
| 640468   | 15   |
| 640469   | 15   |
| 640470   | 15   |
| 640471   | 15   |
| 640472   | 37   |
| 640473   | 37   |
| 640474   | 37   |
| 640475   | 37   |
| 640476   | 37   |
| 640477   | 37   |
| 640478   | 37   |
| 640479   | 37   |
| 640480   | 37   |
| 640481   | 37   |
| 640550   | 16   |
| 640551   | 40   |
| 640556   | 41   |
| 640557   | 41   |
| 640558   | 41   |
| 640559   | 41   |
| 640595   | 39   |
| 640599   | 39   |
| 640600   | 39   |
| 640601   | 39   |
| 640602   | 39   |
| 640604   | 39   |
| 640605   | 39   |
| 640606   | 39   |
| 640607   | 39   |
| 640608   | 39   |
| 640620   | 15   |
| 640621   | 15   |
| 640622   | 15   |
| 640623   | 15   |
| 640629   | 42   |
| 640630   | 42   |
| 640631   | 41   |
| 640632   | 41   |
| 640633   | 41   |
| 640634   | 41   |

| Part No. | Page |
|----------|------|
| 640635   | 41   |
| 640636   | 17   |
| 640637   | 17   |
| 640638   | 17   |
| 640639   | 17   |
| 640642   | 16   |
| 640643   | 40   |
| 640706   | 59   |
| 640707   | 59   |
| 640708   | 17   |
| 640709   | 17   |
| 640859   | 56   |
| 640860   | 56   |
| 640861   | 56   |
| 640862   | 56   |
| 640863   | 56   |
| 640864   | 56   |
| 640865   | 56   |
| 640866   | 56   |
| 640867   | 56   |
| 640868   | 56   |
| 641101   | 57   |
| 641106   | 57   |
| 641113   | 46   |
| 641114   | 46   |
| 641115   | 47   |
| 641118   | 49   |
| 641119   | 48   |
| 641120   | 48   |
| 641121   | 49   |
| 641122   | 21   |
| 641123   | 21   |
| 641124   | 23   |
| 641125   | 23   |
| 641126   | 24   |
| 641127   | 24   |
| 641143   | 41   |
| 641144   | 41   |
| 641145   | 41   |
| 641146   | 41   |
| 641147   | 41   |
| 641148   | 37   |
| 641149   | 37   |
| 641150   | 37   |
| 641151   | 37   |
| 641152   | 37   |
| 641153   | 37   |
| 641154   | 37   |
| 641155   | 37   |
| 641156   | 37   |
| 641157   | 37   |
| 641168   | 39   |
| 641169   | 39   |
| 641170   | 39   |
| 641171   | 39   |
| 641172   | 39   |
| 641173   | 39   |
| 641174   | 39   |
| 641175   | 39   |
| 641176   | 39   |
| 641177   | 39   |
| 641186   | 17   |

| Part No. | Page |
|----------|------|
| 641187   | 17   |
| 641188   | 17   |
| 641189   | 17   |
| 641190   | 15   |
| 641191   | 15   |
| 641192   | 15   |
| 641193   | 15   |
| 641198   | 15   |
| 641199   | 15   |
| 641200   | 15   |
| 641201   | 15   |
| 641202   | 46   |
| 641203   | 46   |
| 641204   | 47   |
| 641207   | 49   |
| 641208   | 48   |
| 641209   | 48   |
| 641210   | 49   |
| 641211   | 21   |
| 641212   | 21   |
| 641213   | 23   |
| 641214   | 23   |
| 641215   | 24   |
| 641216   | 24   |
| 641217   | 37   |
| 641218   | 37   |
| 641219   | 37   |
| 641220   | 37   |
| 641221   | 37   |
| 641222   | 37   |
| 641223   | 37   |
| 641224   | 37   |
| 641225   | 37   |
| 641226   | 37   |
| 641227   | 39   |
| 641228   | 39   |
| 641229   | 39   |
| 641230   | 39   |
| 641231   | 39   |
| 641232   | 39   |
| 641233   | 39   |
| 641234   | 39   |
| 641235   | 39   |
| 641236   | 39   |
| 641237   | 15   |
| 641238   | 15   |
| 641239   | 15   |
| 641240   | 15   |
| 641241   | 15   |
| 641242   | 15   |
| 641243   | 15   |
| 641244   | 15   |
| 641283   | 56   |
| 641284   | 56   |
| 641285   | 56   |
| 641286   | 56   |
| 641287   | 56   |
| 641288   | 56   |
| 641289   | 56   |
| 641290   | 56   |
| 641291   | 56   |
| 641292   | 56   |

**Part Number Index** (Continued)

| Part No. | Page | Part No. | Page | Part No. | Page | Part No. | Page |
|----------|------|----------|------|----------|------|----------|------|
| 641293   | 57   | 643995   | 45   | 644574   | 15   | 644876   | 23   |
| 641301   | 39   | 644020   | 15   | 644575   | 15   | 644877   | 23   |
| 641302   | 39   | 644038   | 15   | 644576   | 15   | 644878   | 37   |
| 641303   | 39   | 644040   | 15   | 644577   | 15   | 644884   | 22   |
| 641304   | 39   | 644042   | 15   | 644578   | 15   | 644885   | 22   |
| 641305   | 39   | 644043   | 15   | 644579   | 15   | 644886   | 22   |
| 641306   | 39   | 644044   | 15   | 644611   | 50   | 644887   | 22   |
| 641307   | 39   | 644082   | 37   | 644612   | 50   | 644888   | 22   |
| 641308   | 39   | 644083   | 15   | 644613   | 51   | 644889   | 22   |
| 641309   | 39   | 644284   | 37   | 644614   | 51   | 644890   | 22   |
| 641310   | 39   | 644312   | 15   | 644615   | 50   | 644891   | 22   |
| 641311   | 15   | 644313   | 15   | 644616   | 50   | 644892   | 32   |
| 641312   | 15   | 644329   | 55   | 644617   | 51   | 644893   | 32   |
| 641313   | 15   | 644370   | 55   | 644627   | 50   | 644894   | 32   |
| 641314   | 15   | 644371   | 55   | 644628   | 50   | 644896   | 32   |
| 641425   | 45   | 644375   | 55   | 644629   | 51   | 644897   | 32   |
| 641426   | 45   | 644376   | 55   | 644630   | 51   | 644898   | 32   |
| 641427   | 45   | 644377   | 55   | 644631   | 50   | 647000   | 20   |
| 641428   | 45   | 644381   | 55   | 644632   | 50   | 647001   | 20   |
| 641429   | 45   | 644382   | 55   | 644633   | 51   | 647002   | 20   |
| 641435   | 45   | 644383   | 55   | 644662   | 37   | 647003   | 20   |
| 641436   | 45   | 644387   | 55   | 644663   | 37   | 647004   | 20   |
| 641437   | 45   | 644388   | 55   | 644687   | 37   | 647005   | 20   |
| 641438   | 45   | 644389   | 55   | 644694   | 22   | 647006   | 20   |
| 641439   | 45   | 644456   | 22   | 644695   | 22   | 647007   | 20   |
| 641440   | 42   | 644457   | 22   | 644702   | 15   | 647008   | 20   |
| 641522   | 45   | 644460   | 37   | 644718   | 39   | 647009   | 20   |
| 641523   | 45   | 644461   | 37   | 644720   | 39   | 647010   | 20   |
| 641524   | 45   | 644462   | 37   | 644726   | 15   | 647011   | 20   |
| 641525   | 45   | 644463   | 37   | 644749   | 46   | 647012   | 20   |
| 641526   | 45   | 644464   | 37   | 644750   | 46   | 647013   | 20   |
| 641533   | 42   | 644465   | 39   | 644751   | 47   | 647014   | 20   |
| 641534   | 15   | 644466   | 39   | 644752   | 48   | 647015   | 20   |
| 641535   | 15   | 644467   | 39   | 644753   | 48   | 647016   | 20   |
| 641536   | 15   | 644468   | 39   | 644754   | 49   | 647017   | 20   |
| 641537   | 15   | 644469   | 39   | 644755   | 49   | 647018   | 20   |
| 641550   | 59   | 644470   | 39   | 644756   | 46   | 647019   | 20   |
| 641623   | 42   | 644471   | 39   | 644757   | 46   | 647020   | 20   |
| 641643   | 17   | 644472   | 39   | 644758   | 47   | 647021   | 20   |
| 641644   | 17   | 644486   | 30   | 644759   | 48   | 647022   | 20   |
| 641645   | 17   | 644487   | 30   | 644760   | 48   | 647023   | 20   |
| 641646   | 17   | 644488   | 30   | 644761   | 49   | 647030   | 20   |
| 641653   | 15   | 644489   | 30   | 644762   | 49   | 647031   | 20   |
| 641654   | 15   | 644497   | 15   | 644763   | 46   | 647032   | 20   |
| 641655   | 15   | 644501   | 37   | 644764   | 46   | 647033   | 20   |
| 641656   | 15   | 644502   | 37   | 644765   | 47   | 647047   | 27   |
| 641994   | 17   | 644508   | 55   | 644766   | 48   | 647048   | 27   |
| 643067   | 40   | 644509   | 55   | 644767   | 48   | 647050   | 28   |
| 643071   | 40   | 644510   | 55   | 644768   | 49   | 647051   | 28   |
| 643075   | 16   | 644511   | 15   | 644769   | 49   | 647075   | 27   |
| 643077   | 16   | 644512   | 15   | 644783   | 37   | 647076   | 27   |
| 643498   | 15   | 644513   | 15   | 644791   | 37   | 647078   | 28   |
| 643813   | 15   | 644514   | 15   | 644795   | 15   | 647079   | 28   |
| 643814   | 15   | 644540   | 15   | 644803   | 30   | 647106   | 29   |
| 643815   | 15   | 644563   | 15   | 644807   | 45   | 647107   | 29   |
| 643816   | 15   | 644564   | 15   | 644809   | 45   | 647108   | 29   |
| 643817   | 37   | 644565   | 15   | 644812   | 45   | 647109   | 27   |
| 643818   | 37   | 644566   | 37   | 644814   | 45   | 647114   | 27   |
| 643819   | 37   | 644567   | 39   | 644860   | 37   | 647116   | 28   |
| 643820   | 37   | 644569   | 39   | 644861   | 30   | 647117   | 28   |
| 643821   | 37   | 644570   | 39   | 644874   | 24   | 647123   | 53   |
| 643828   | 15   | 644572   | 39   | 644875   | 24   | 647124   | 53   |

### Part Number Index (Continued)

| Part No. | Page | Part No. | Page   | Part No. | Page | Part No. | Page |
|----------|------|----------|--------|----------|------|----------|------|
| 647125   | 53   | 647478   | 37     | 1123723  | 65   | 1445351  | 7    |
| 647126   | 53   | 647479   | 39     | 1123724  | 68   | 1445352  | 7    |
| 647127   | 53   | 647480   | 15     | 1123823  | 69   | 1445353  | 7    |
| 647128   | 53   | 647481   | 45     | 1123824  | 69   | 1445354  | 7    |
| 647131   | 53   | 647485   | 62     | 1318300  | 65   | 1445355  | 7    |
| 647132   | 53   | 647496   | 39     | 1318301  | 68   | 1445356  | 7    |
| 647133   | 53   | 647497   | 45     | 1318831  | 69   | 1445357  | 7    |
| 647134   | 53   | 647609   | 25     | 1318912  | 64   | 1445358  | 7    |
| 647135   | 53   | 647623   | 25     | 1375819  | 31   | 1445359  | 5    |
| 647136   | 53   | 647624   | 25     | 1375820  | 31   | 1445360  | 5    |
| 647139   | 53   | 647625   | 25     | 1445120  | 9    | 1445361  | 5    |
| 647140   | 53   | 647626   | 25     | 1445121  | 10   | 1445362  | 5    |
| 647141   | 53   | 647627   | 25     | 1445123  | 9    | 1445363  | 5    |
| 647142   | 53   | 647628   | 26     | 1445124  | 10   | 1445364  | 5    |
| 647143   | 53   | 647629   | 26     | 1445125  | 9    | 1445365  | 5    |
| 647144   | 53   | 647630   | 26     | 1445126  | 10   | 1445366  | 5    |
| 647166   | 29   | 647646   | 47     | 1445169  | 9    | 1445367  | 5    |
| 647167   | 29   | 647648   | 52     | 1445170  | 9    | 1445368  | 5    |
| 647168   | 29   | 647649   | 52     | 1445171  | 9    | 1445369  | 5    |
| 647295   | 28   | 647651   | 26     | 1445172  | 10   | 1445370  | 5    |
| 647296   | 28   | 647652   | 26     | 1445173  | 10   | 1445371  | 5    |
| 647297   | 28   | 647653   | 26     | 1445174  | 10   | 1445372  | 5    |
| 647298   | 27   | 647676   | 65     | 1445336  | 31   | 1445373  | 5    |
| 647299   | 27   | 647689   | 65     | 1445341  | 7    | 1445374  | 5    |
| 647300   | 27   | 647690   | 64     | 1445342  | 7    | 1445375  | 5    |
| 647400   | 62   | 770258   | 59     | 1445343  | 7    | 1445376  | 5    |
| 647401   | 62   | 770476   | 59, 60 | 1445344  | 7    | 1744017  | 48   |
| 647402   | 62   | 770522   | 59     | 1445345  | 7    | 1744020  | 15   |
| 647406   | 62   | 770849   | 60     | 1445346  | 7    | 1744036  | 67   |
| 647409   | 62   | 770894   | 61     | 1445347  | 7    | 1744037  | 67   |
| 647466   | 62   | 971111   | 71     | 1445348  | 7    | 1744048  | 67   |
| 647476   | 45   | 1123721  | 64     | 1445349  | 7    | 1744055  | 66   |
| 647477   | 15   | 1123722  | 64     | 1445350  | 7    | 1744056  | 66   |

### Application Tooling Part Number Index

| Part No. | Page       | Part No. | Page       | Part No. | Page       | Part No. | Page       |
|----------|------------|----------|------------|----------|------------|----------|------------|
| 58009    | 76, 79     | 58517    | 31         | 91112    | 78, 79     | 853547   | 76, 79     |
| 58010    | 76, 79     | 58575    | 76, 78, 79 | 91579    | 64         | 854175   | 76, 79     |
| 58024    | 76, 78, 79 | 58576    | 76, 78, 79 | 312522   | 76, 78, 79 | 854176   | 76, 79     |
| 58039    | 76, 79     | 58579    | 76         | 354500   | 79         | 854200   | 76, 79     |
| 58040    | 76, 79     | 58614    | 59         | 466468   | 59         | 854449   | 78         |
| 58061    | 76, 79     | 58635    | 76, 79     | 466727   | 76, 79     | 854468   | 78, 79     |
| 58074    | 76, 77, 79 | 58636    | 76, 79     | 466728   | 76, 79     | 856600   | 76, 79     |
| 58075    | 76, 77     | 58638    | 76, 79     | 466747   | 17         | 931800   | 76, 77, 79 |
| 58082    | 76, 79     | 58639    | 76         | 466947   | 59         | 933567   | 76, 79     |
| 58242    | 76, 79     | 58644    | 76, 79     | 471273   | 78, 79     | 933568   | 76, 79     |
| 58243    | 76, 79     | 58646    | 76, 79     | 567020   | 76, 79     | 1385286  | 64         |
| 58244    | 76, 79     | 59803    | 76, 79     | 567373   | 31         | 1583503  | 76, 79     |
| 58245    | 76, 79     | 59804    | 76, 79     | 567827   | 31         | 1583514  | 76, 79     |
| 58246    | 76, 79     | 59836    | 17         | 567828   | 59         | 1583515  | 76, 79     |
| 58247    | 76, 79     | 59837    | 41         | 567910   | 31         | 1583516  | 76, 79     |
| 58338    | 76, 77, 79 | 59839    | 76         | 680211   | 59         | 1583517  | 76, 79     |
| 58392    | 76, 79     | 59845    | 79         | 690675   | 78, 79     | 1583518  | 76, 79     |
| 58442    | 76, 79     | 59848    | 76, 79     | 853542   | 76, 79     |          |            |
| 58443    | 76, 79     | 90471    | 59         | 853546   | 76, 79     |          |            |



## Americas

**Argentina** – Buenos Aires  
Phone: +54-11-4733-2200  
Fax: +54-11-4733-2211

**Brasil** – São Paulo  
Phone: +55-11-2103-6000  
Fax: +55-11-2103-6030

**Chile** – Santiago  
Phone: +56-2-345-0361  
Fax: +56-2-223-1477

**Canada** – Toronto  
Phone: +905-475-6222  
Fax: +905-474-5520  
Product Information Center:  
Phone: +905-470-4425  
Fax: +905-474-5525

**Colombia** – Bogota  
Phone: +57-1-319-8959  
Fax: +57-1-319-8960

**Mexico** – Mexico City  
Phone: +52-55-1106-0800  
+01-800-733-8926  
Fax: +52-55-1106-0901

**For Latin/South American Countries not shown**  
Phone: +54-11-4733-2015  
Fax: +54-11-4733-2083

**United States**  
Harrisburg, PA  
Phone: +1-717-564-0100  
Fax: +1-717-986-7575  
Product Information Center:  
Phone: +1-800-522-6752  
Fax: +1-717-986-7575  
Troy, MI  
Phone: +1-248-273-3359  
Fax: +1-248-273-3322

## Asia/Pacific

**Australia** – Sydney  
Phone: +61-2-9554-2600  
Fax: +61-2-9502-2556  
Product Information Center:  
Phone: +61-2-9840-8200  
Fax: +61-2-9634-6188

**India** – Bangalore  
Phone: +91-80-285-40800  
Fax: +91-80-285-40820

**Indonesia** – Jakarta  
Phone: +65-6482-0311  
Fax: +65-6482-1012

**Japan** – Kawasaki, Kanagawa  
Phone: +81-44-844-8111  
Fax: +81-44-812-3207  
Product Information Center:  
Phone: +81-44-844-8013  
Fax: +81-44-812-3200

**Korea** – Seoul  
Phone: +82-2-3415-4500  
Fax: +82-2-3486-3810

**Malaysia** – Selangor  
Phone: +60-3-7805-3055  
Fax: +60-3-7805-3066

**New Zealand** – Auckland  
Phone: +64-9-634-4580  
Fax: +64-9-634-4586

**Philippines** – Makati City  
Phone: +632-848-0171  
Fax: +632-867-8661

**People's Republic of China**  
Hong Kong  
Phone: +852-2735-1628  
Fax: +852-2735-0243  
Shanghai  
Phone: +86-21-2407-1588  
Fax: +86-21-2407-1599

**Singapore** – Singapore  
Phone: +65-6482-0311  
Fax: +65-6482-1012

**Taiwan** – Taipei  
Phone: +886-2-8768-2788  
Fax: +886-2-8768-2268

**Thailand** – Bangkok  
Phone: +66-2-955-0500  
Fax: +66-2-955-0505

**Vietnam** – Ho Chi Minh City  
Phone: +84-8-930-5546  
Fax: +84-8-930-3443

## Europe/Middle East/Africa

**Austria** – Vienna  
Phone: +43-1-905-60-0  
Fax: +43-1-905-60-1333  
Product Information Center:  
Phone: +43-1-905-60-1249  
Fax: +43-1-905-60-1251

**Belarus** – Minsk  
Phone: +375 17 237 47 94  
Fax: +375 17 237 47 94

**Belgium** – Kessel-Lo  
Phone: +32-16-352-300  
Fax: +32-16-352-355

**Bulgaria** – Sofia  
Phone: +359-2-971-2152  
Fax: +359-2-971-2153

**Czech Republic and Slovakia**  
**Czech Republic** – Kurim  
Phone: +420-541-162-111  
Fax: +420-541-162-223  
Product Information Center:  
Phone: +420-541-162-113  
Fax: +420-541-162-132

**Denmark** – Glostrup  
Phone: +45-43-48-04-00  
Fax: +45-43-44-14-14

**Egypt** – Cairo  
Phone: +202-419-2334  
Fax: +202-417-7647

**Estonia** – Tartu  
Phone: +372-5138-274  
Fax: +372-7400-779

**Finland** – Helsinki  
Phone: +358-95-12-34-20  
Fax: +358-95-12-34-250

**France** – Cergy-Pontoise Cedex  
Phone: +33-1-3420-8888  
Fax: +33-1-3420-8600  
Product Information Center:  
Phone: +33-1-3420-8686  
Fax: +33-1-3420-8623

**France Export Divisions** –  
Cergy-Pontoise Cedex  
Phone: +33-1-3420-8804  
Fax: +33-1-3420-8699

**Germany** – Bensheim  
Phone: +49-6251-133-0  
Fax: +49-6251-133-1600  
Product Information Center:  
Phone: +49-6251-133-1999  
Fax: +49-6251-133-1988

**Greece** – Athens  
Phone: +30-210-9370-396/397  
Fax: +30-210-9370-655

**Hungary** – Budapest  
Phone: +36-1-289-1000  
Fax: +36-1-289-1010  
Product Information Center:  
Phone: +36-1-289-1016  
Fax: +36-1-289-1017

**Ireland** – Dublin  
Phone: +353-1-866-5612  
Fax: +353-1-866-5714

**Israel** – Petach-Tikva  
Phone: +972-3-929-0999  
Fax: +972-3-919-1088

**Italy** – Collegno (Torino)  
Phone: +39-011-4012-111  
Fax: +39-011-4031-116  
Product Information Center:  
Phone: +39-011-4012-428  
Fax: +39-011-40-287-428

**Lithuania and Latvia**  
**Lithuania** – Vilnius  
Phone: +370-5-213-1402  
Fax: +370-5-213-1403  
Product Information Center:  
Phone: +370-5-211-3016  
Fax: +370-5-213-1403

**Netherlands** – 's-Hertogenbosch  
Phone: +31-73-6246-246  
Fax: +31-73-6212-365  
Product Information Center:  
Phone: +31-73-6246-999  
Fax: +31-73-6246-998

**Norway** – Nesbru  
Phone: +47-66-77-88-50  
Fax: +47-66-77-88-55

**Poland** – Warsaw  
Phone: +48-22-4576-700  
Fax: +48-22-4576-720  
Product Information Center:  
Phone: +48-22-4576-704  
Fax: +48-22-4576-720

**Romania** – Bucharest  
Phone: +40-21-311-3479/3596  
Fax: +40-21-312-0574

**Russia** – Moscow  
Phone: +7-495-790-7902  
Fax: +7-495-721-1893  
Product Information Center:  
Phone: +7-495-790-7902-404  
Fax: +7-495-790-7902-401

**Russia** – St. Petersburg  
Phone: +7-812-718-8192  
Fax: +7-812-718-8193

**Slovenia** – Ljubljana  
Phone: +386-1561-3270  
Fax: +386-1561-3240

**South Africa** – Port Elizabeth  
Phone: +27-41-503-4500  
Fax: +27-41-581-0440

**Spain** – Barcelona  
Phone: +34-93-291-0330  
Fax: +34-93-201-7879

**Sweden** – Upplands Väsby  
Phone: +46-8-50-72-50-00  
Fax: +46-8-50-72-50-01

**Switzerland** – Steinach  
Phone: +41-71-447-0447  
Fax: +41-71-447-0444

**Turkey** – Istanbul  
Phone: +90-212-281-8181/2/3  
+90-212-282-5130/5430  
Fax: +90-212-281-8184

**Ukraine** – Kiev  
Phone: +380-44-206-2265  
Fax: +380-44-206-2264  
Product Information Center:  
Phone: +380-44-206-2265  
Fax: +380-44-206-2264

**United Kingdom** –  
Stanmore, Middlesex  
Phone: +44-8706-080208  
Fax: +44-208-954-6234  
Product Information Center:  
Freephone (UK only):  
0800-267-666  
Phone: +44-8706-080208  
Fax: +44-208-420-8095

**Tyco Electronics Corporation**  
Harrisburg, PA

82056-10K-MS-FP-6-08-OG3B

